

# EXPLODED DRAWING A

Model No. PFEL04916.1 R0118A

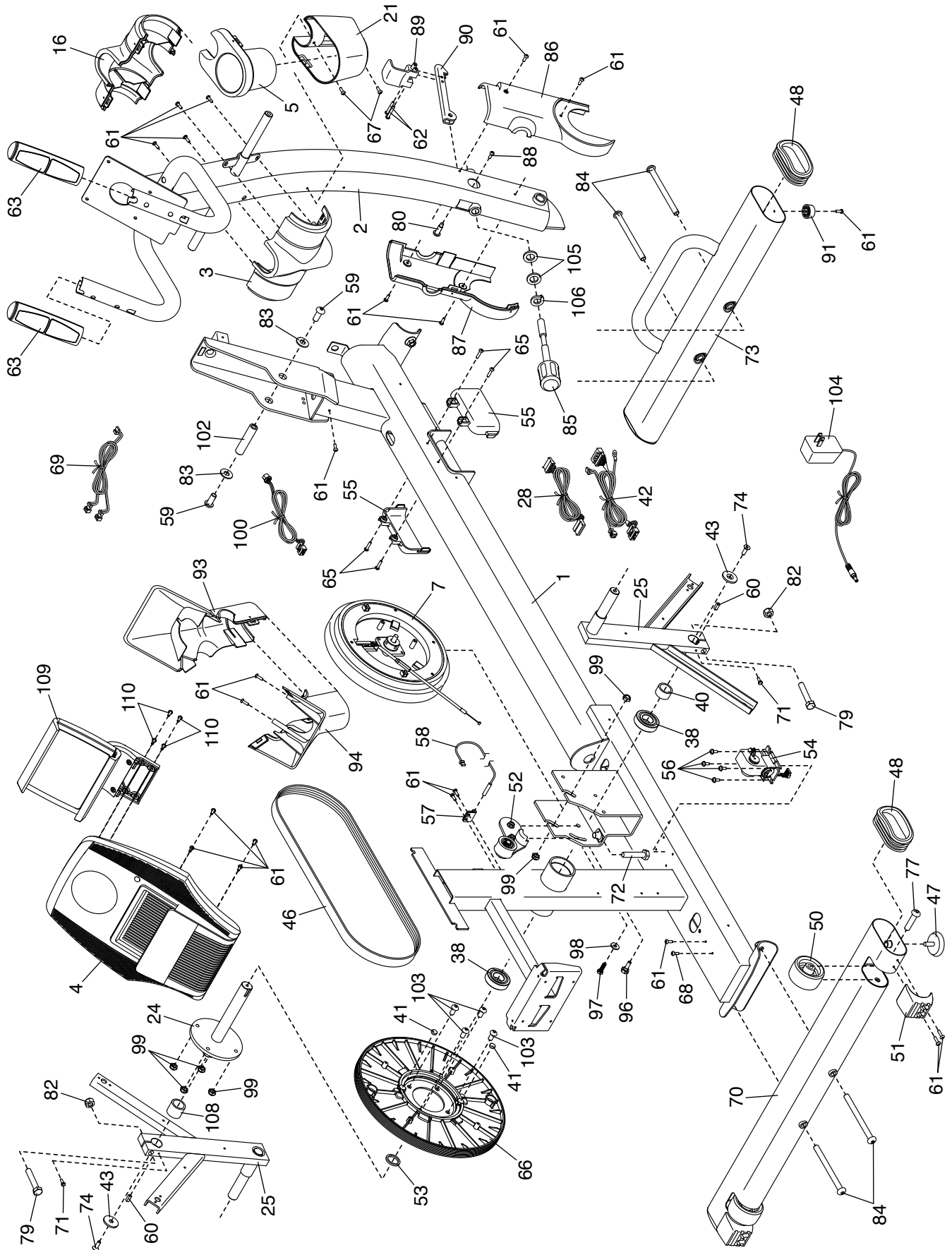

# EXPLODED DRAWING B

Model No. PFEL04916.1 R0118A

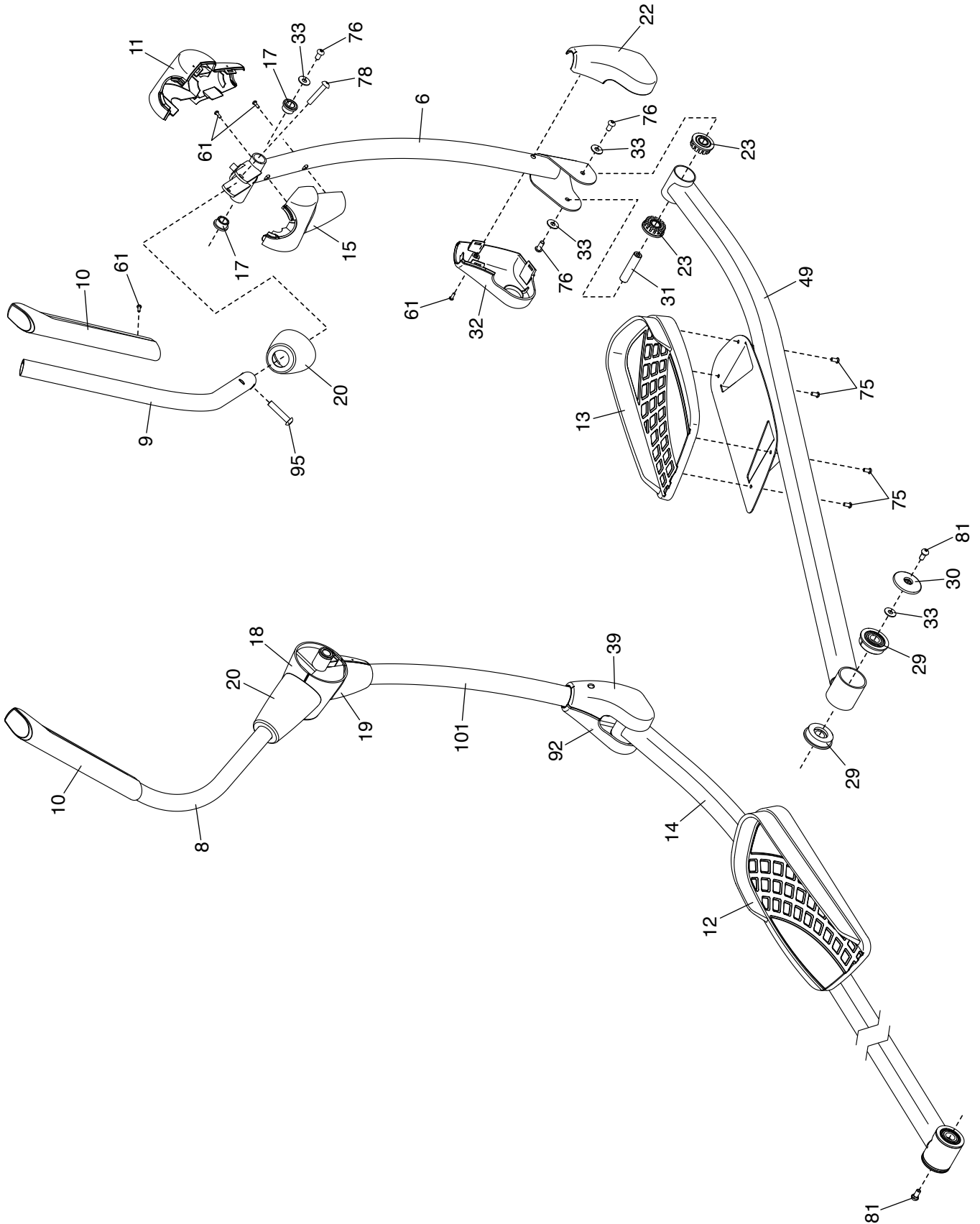

# EXPLODED DRAWING C

Model No. PFEL04916.1 R0118A

