

EXPLODED DRAWING A—Model No. PFEL05809.1

R0610A

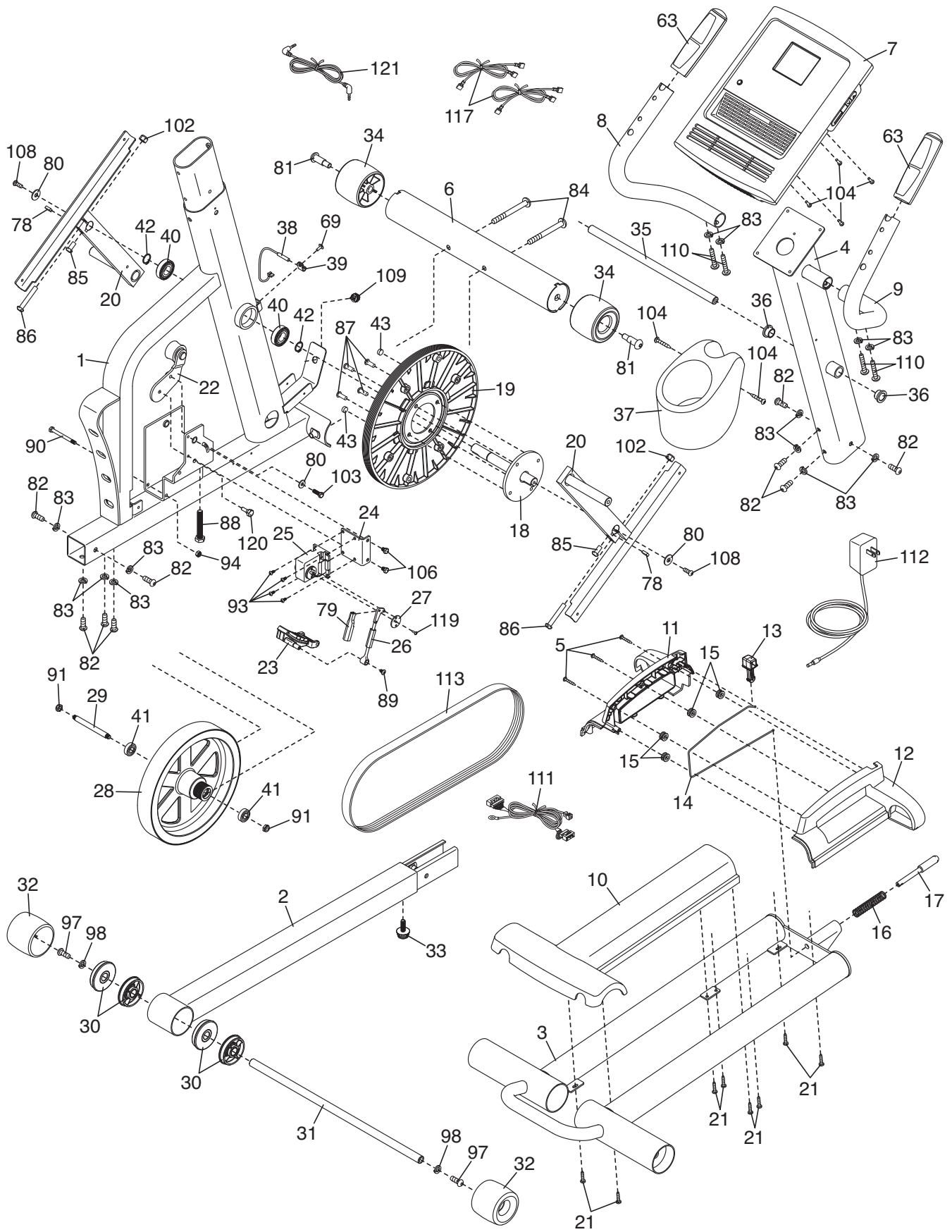

EXPLODED DRAWING B—Model No. PFEL05809.1

R0610A

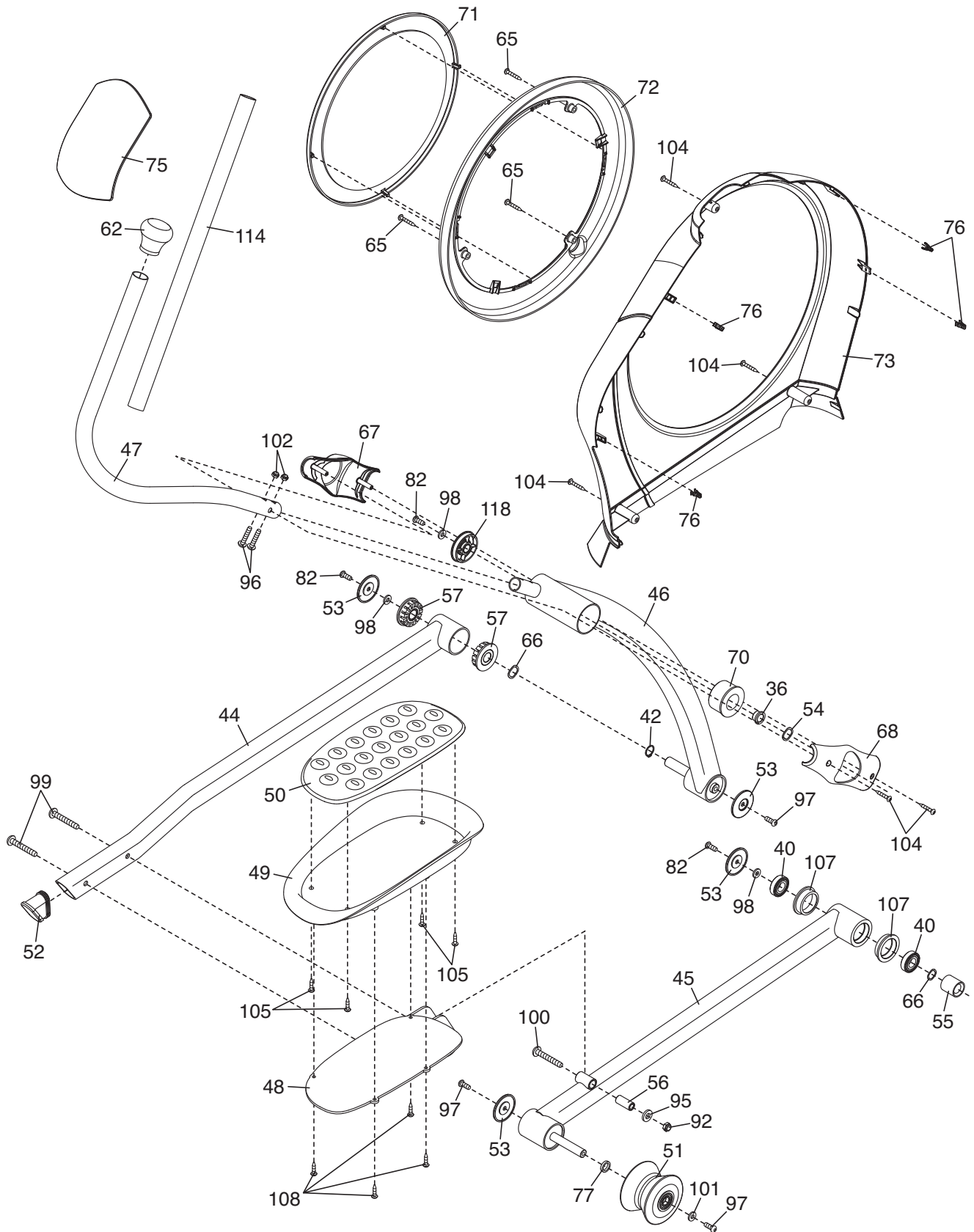

EXPLODED DRAWING C—Model No. PFEL05809.1

R0610A

