

# EXPLODED DRAWING A

Model No. PFEL05813.1 R1213A

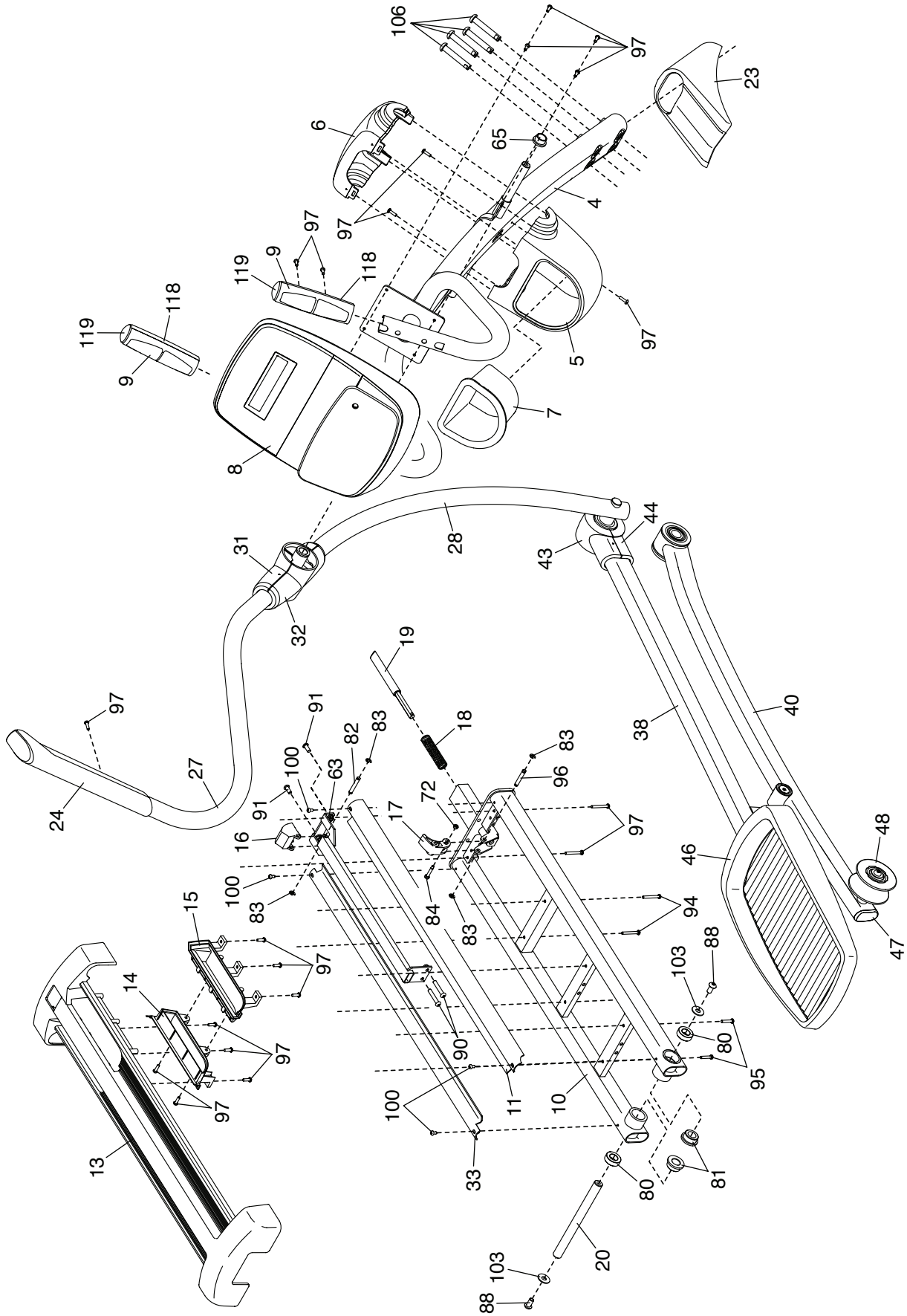

# EXPLODED DRAWING B

Model No. PFEL05813.1 R1213A

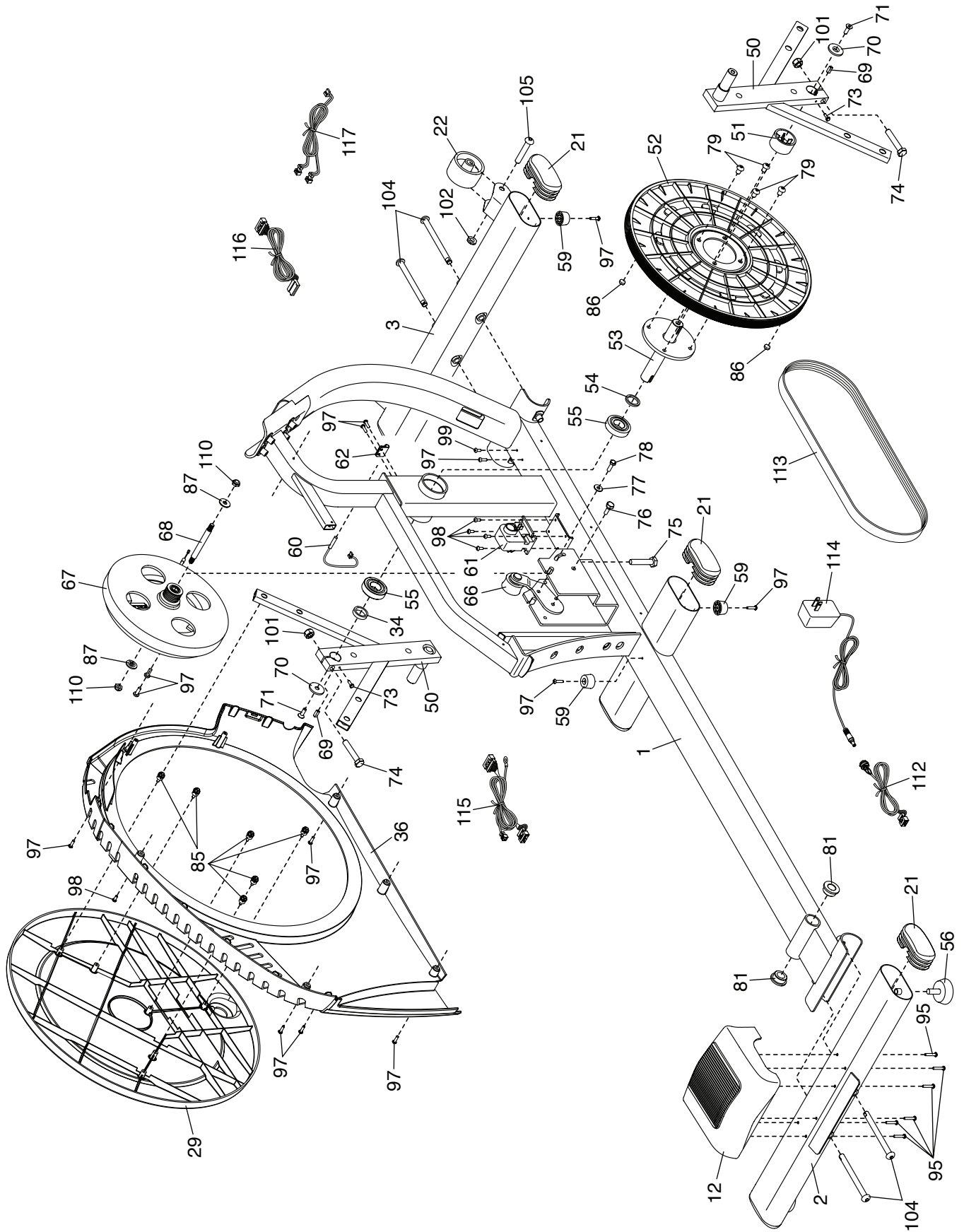

# EXPLODED DRAWING C

Model No. PFEL05813.1 R1213A

