

EXPLODED DRAWING A

Model No. PFEL05813.3 R0914A

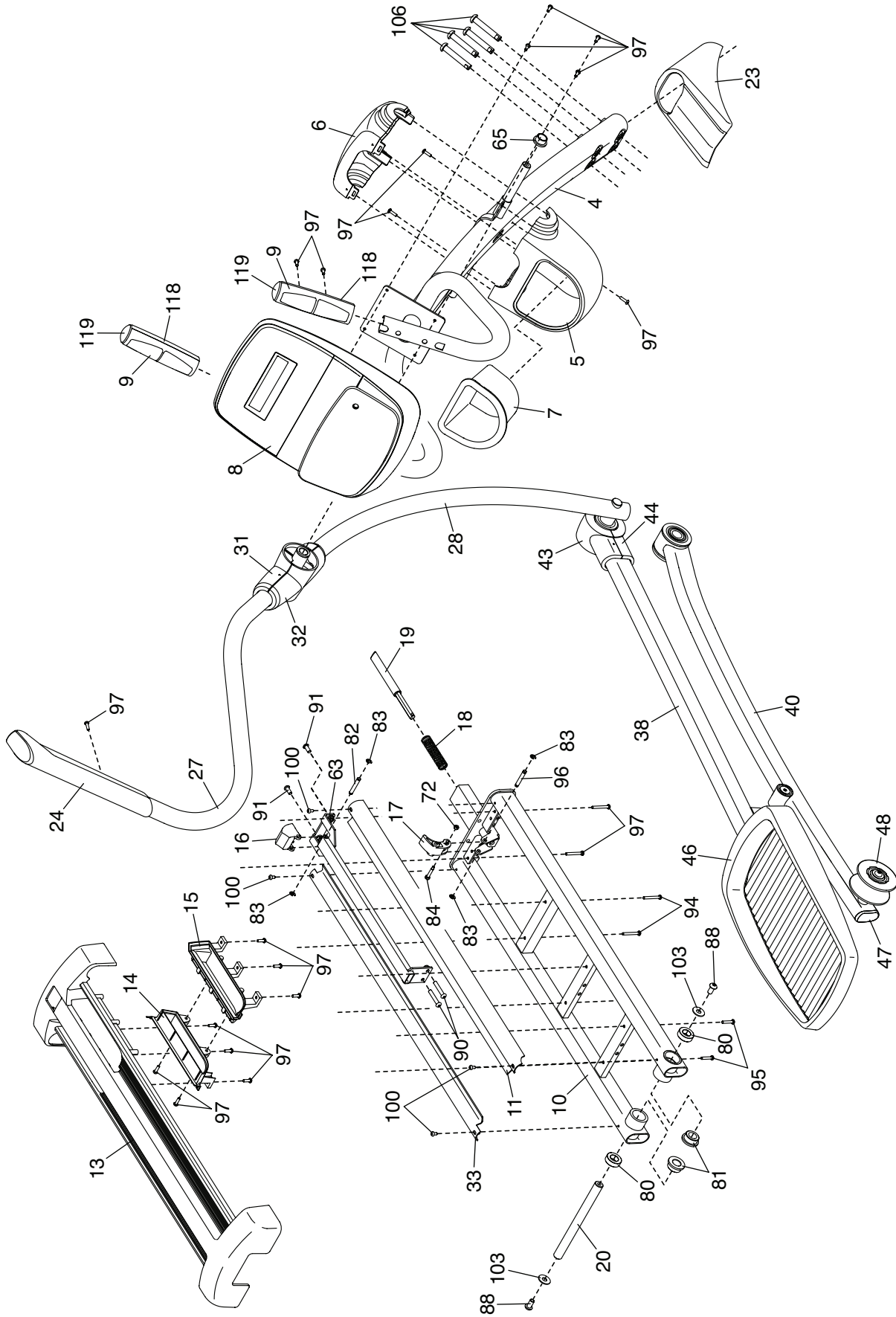

EXPLODED DRAWING B

Model No. PFEL05813.3 R0914A

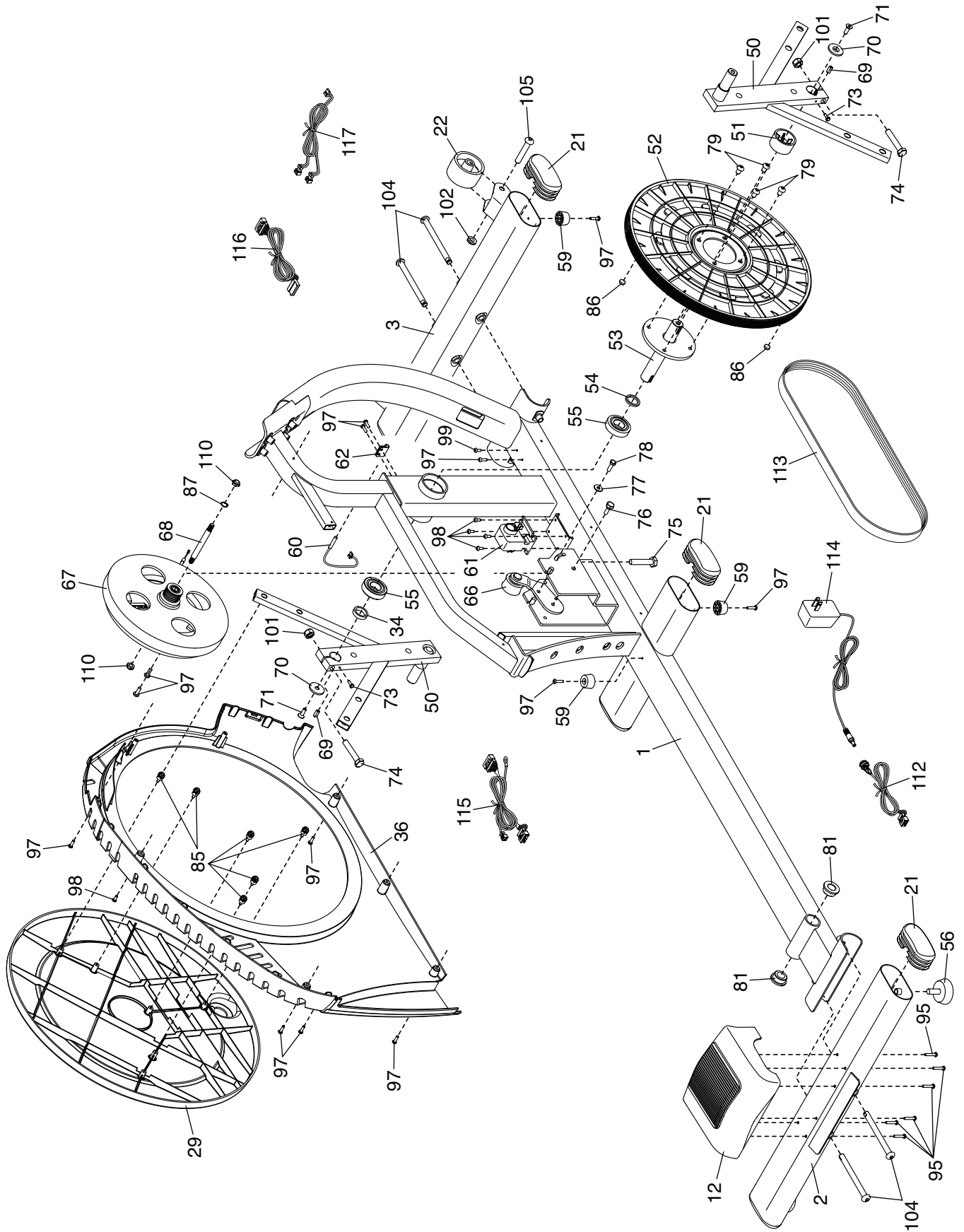

EXPLODED DRAWING C

Model No. PFEL05813.3 R0914A

