

# EXPLODED DRAWING A

Model No. PFEL05911.0 R0112A

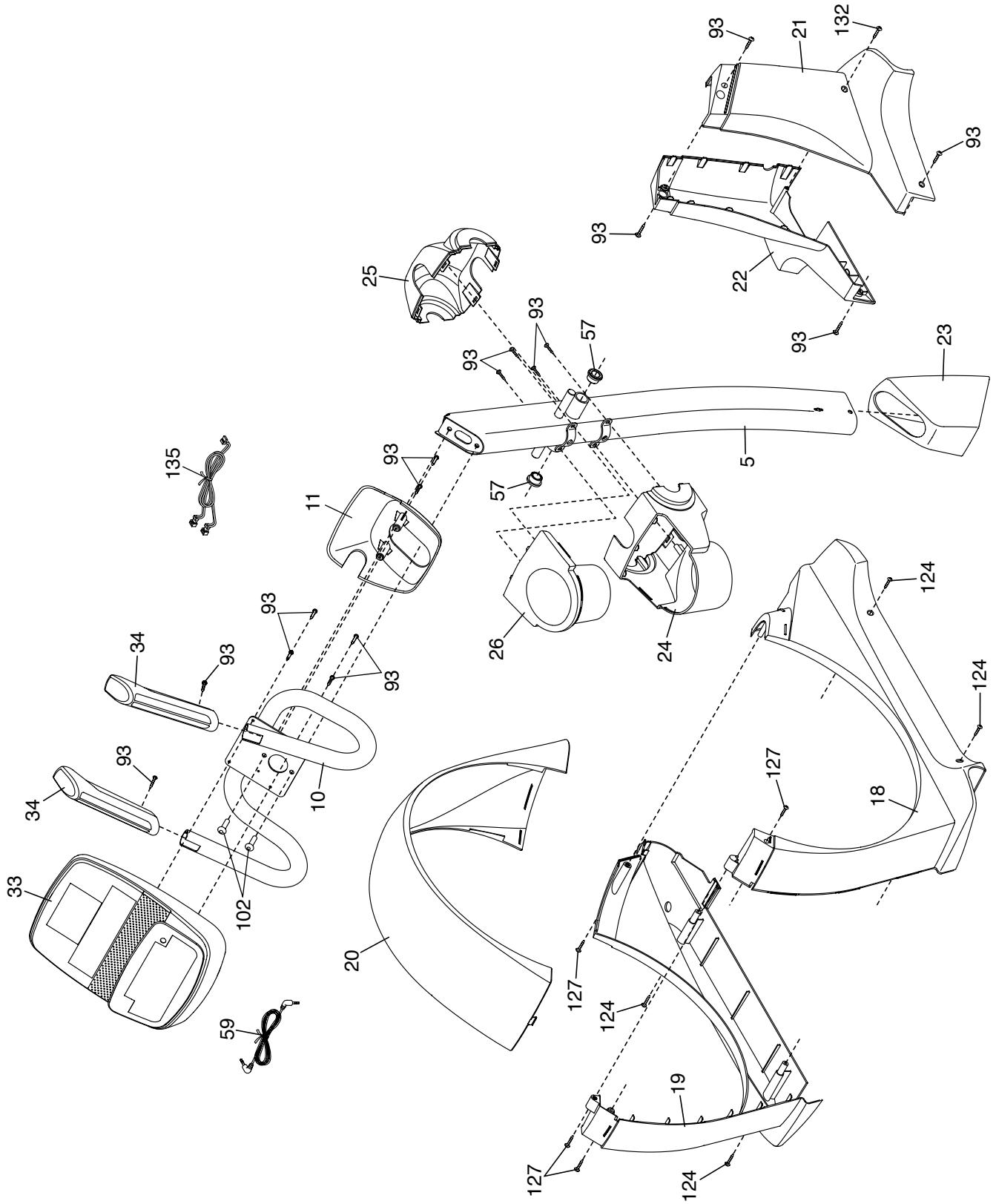

# EXPLODED DRAWING B

Model No. PFEL05911.0 R0112A

