

EXPLODED DRAWING A

Model No. PFEL05911.9 R0512A

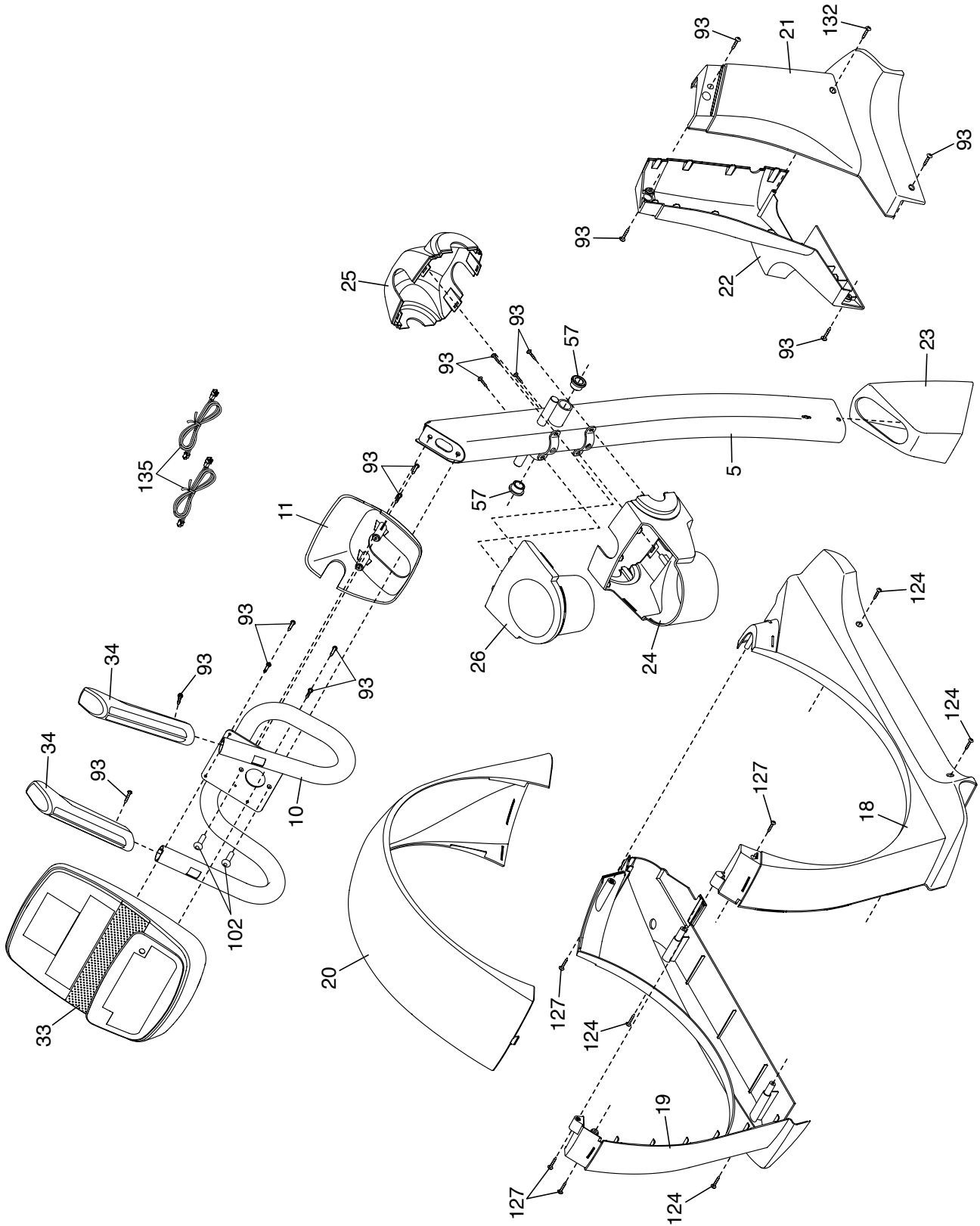

EXPLODED DRAWING C

Model No. PFEL05911.9 R0512A

