

EXPLODED DRAWING A

Model No. PFEL05911.2 R0112A

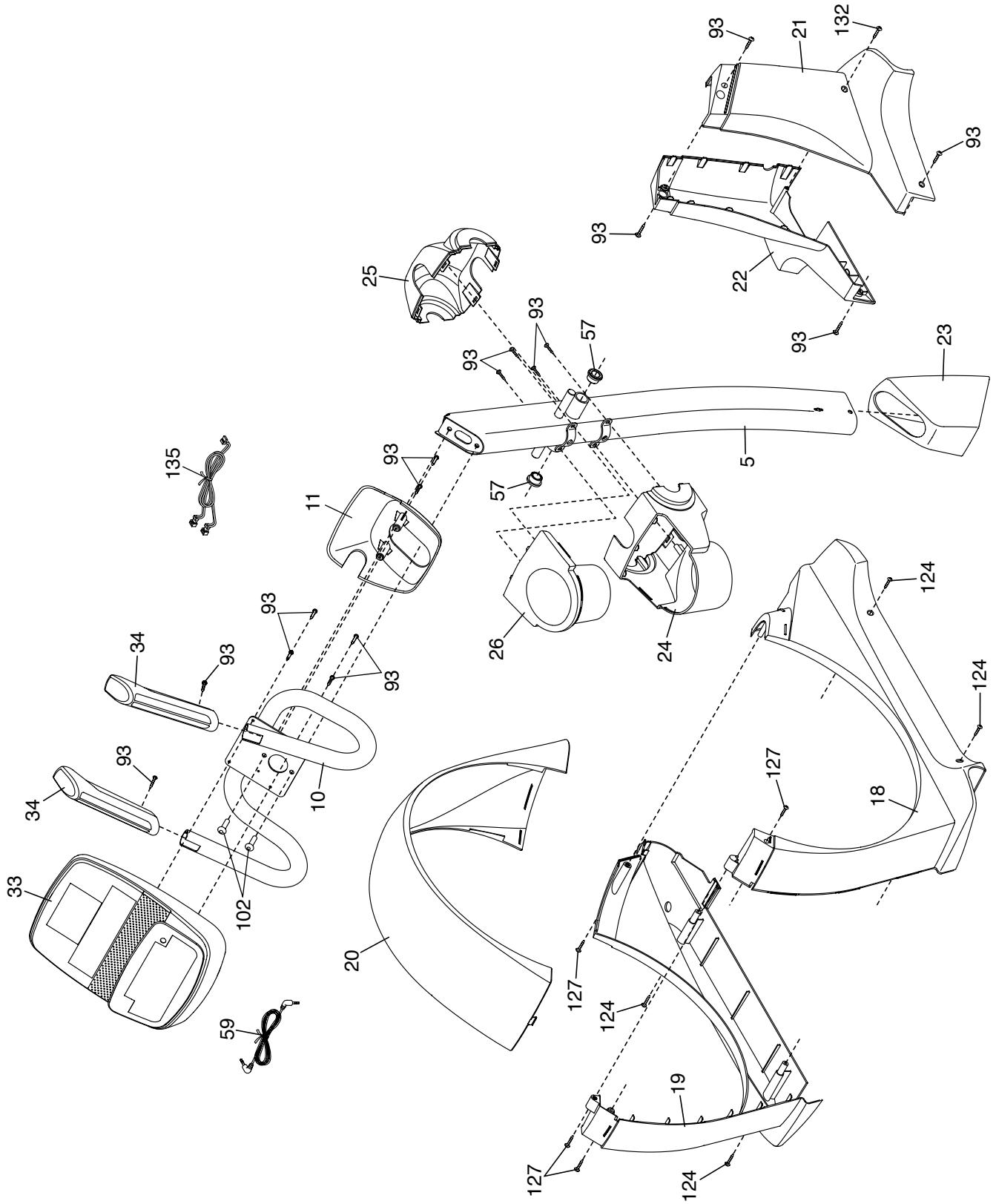

EXPLODED DRAWING B

Model No. PFEL05911.2 R0112A

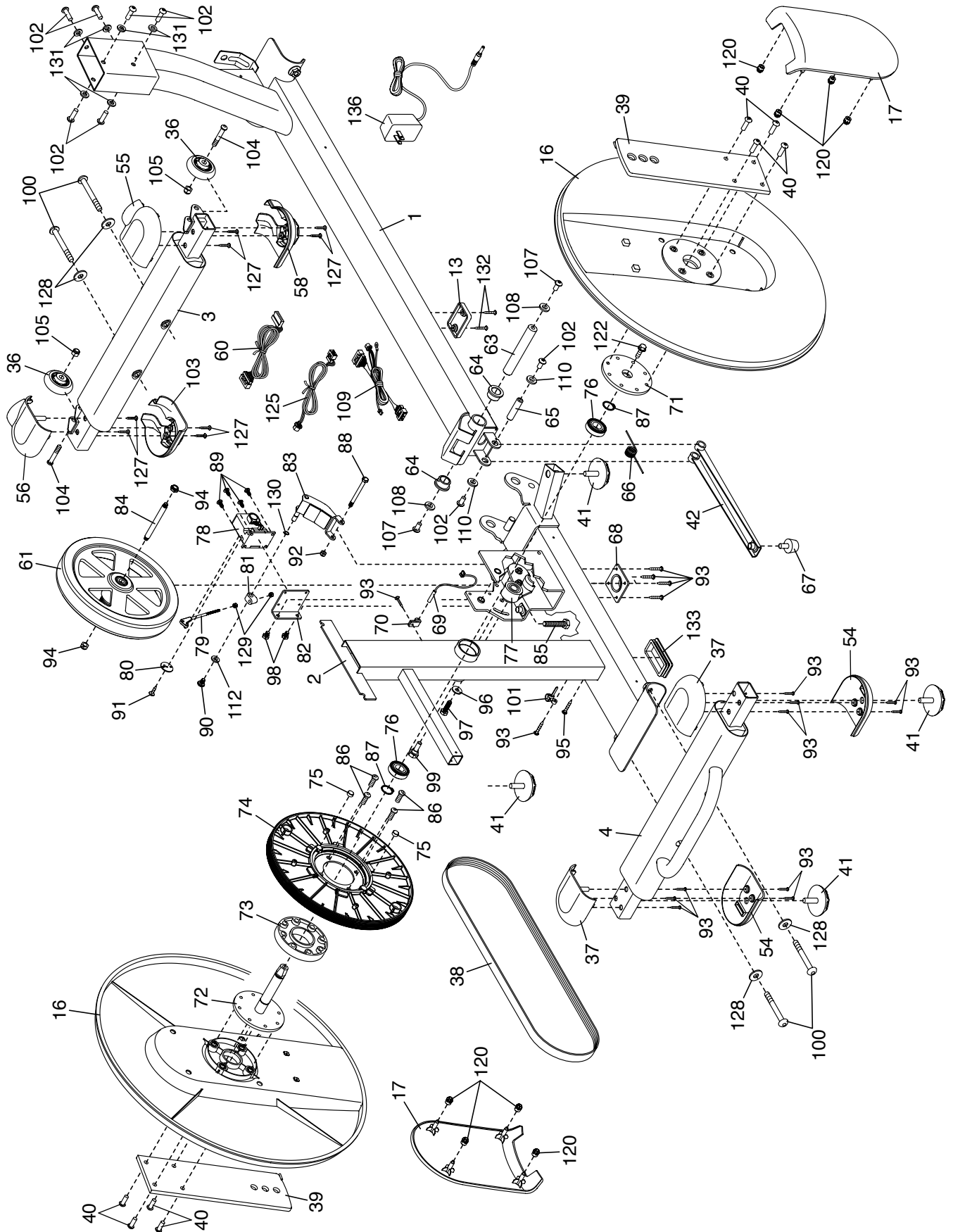

EXPLODED DRAWING C

Model No. PFEL05911.2 R0112A

