

EXPLODED DRAWING A

Model No. PFEL05911.3 R1111A

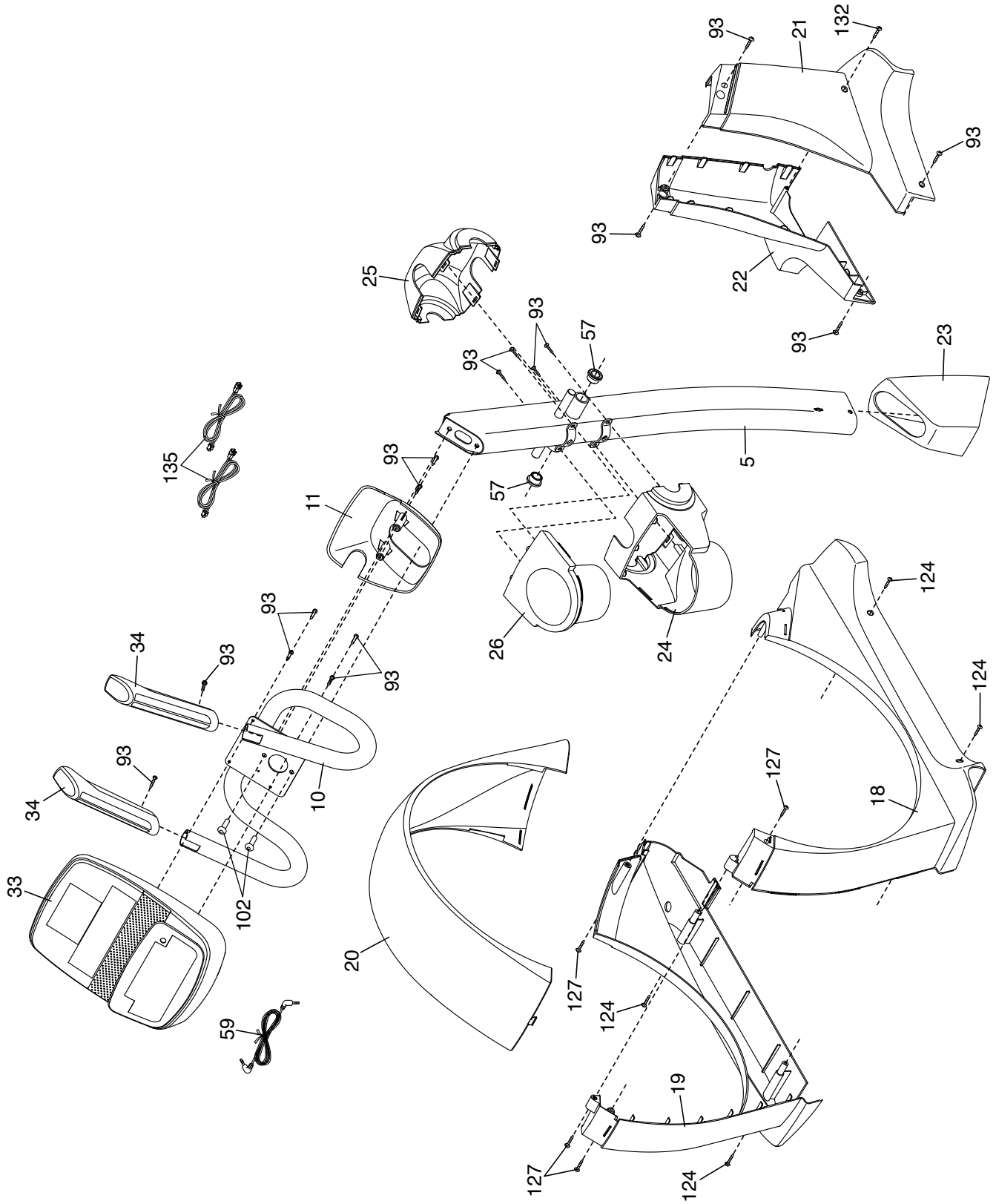

EXPLODED DRAWING B

Model No. PFEL05911.3 R1111A

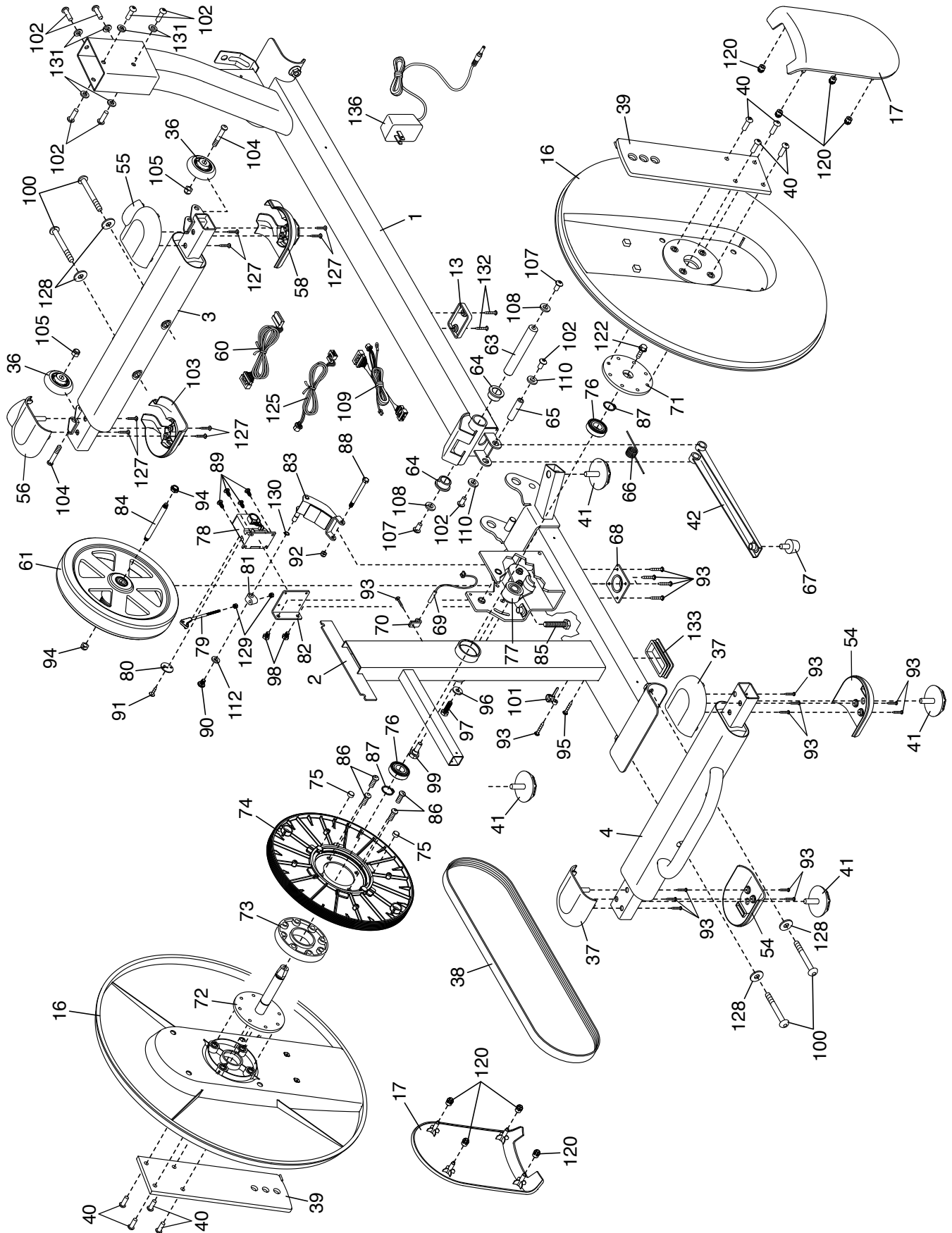

EXPLODED DRAWING C

Model No. PFEL05911.3 R1111A

