

EXPLODED DRAWING A

Model No. PFEL05911.4 R1111A

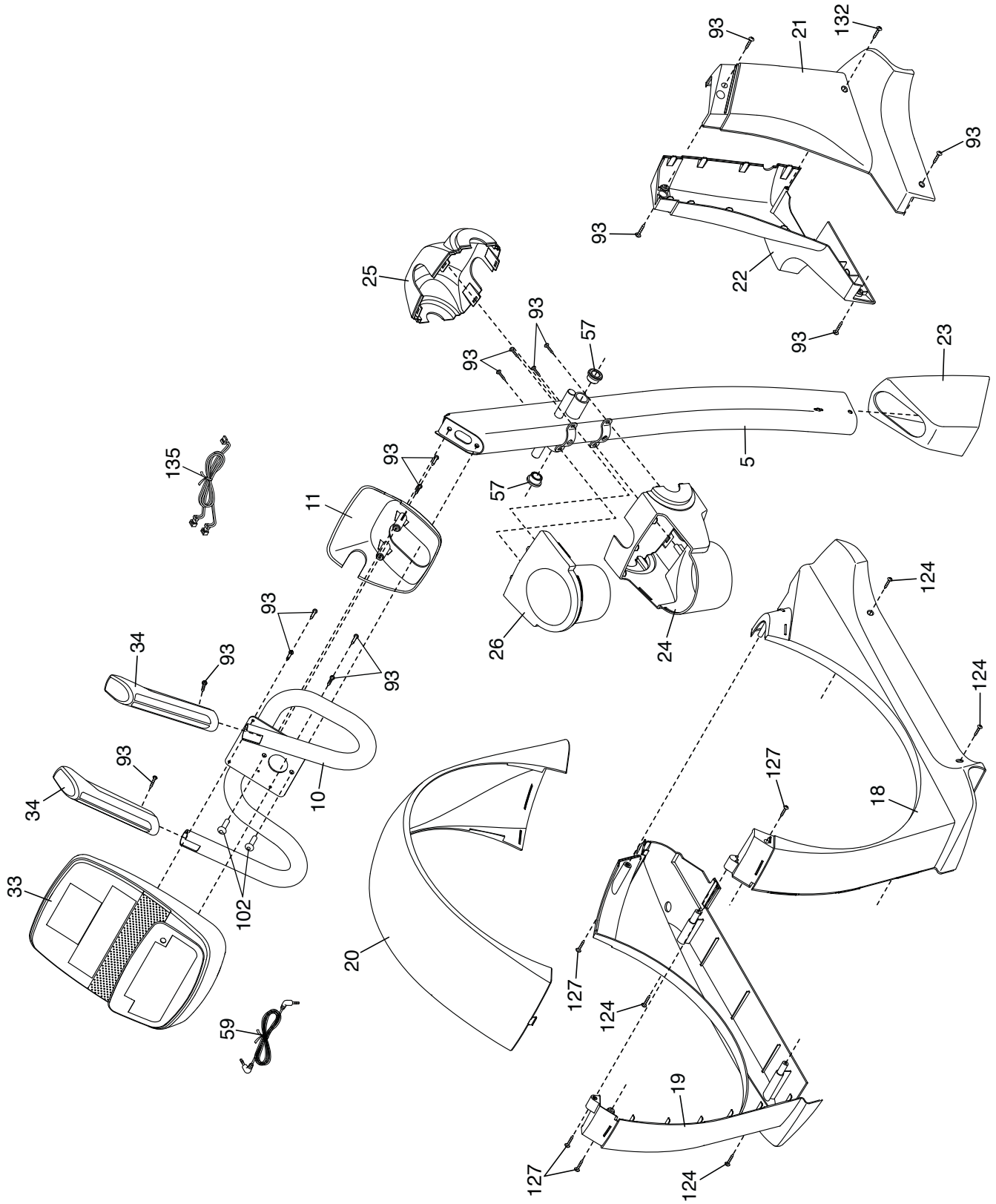

EXPLODED DRAWING C

Model No. PFEL05911.4 R1111A

