

EXPLODED DRAWING A

Model No. PFEL05918.2 R0919A

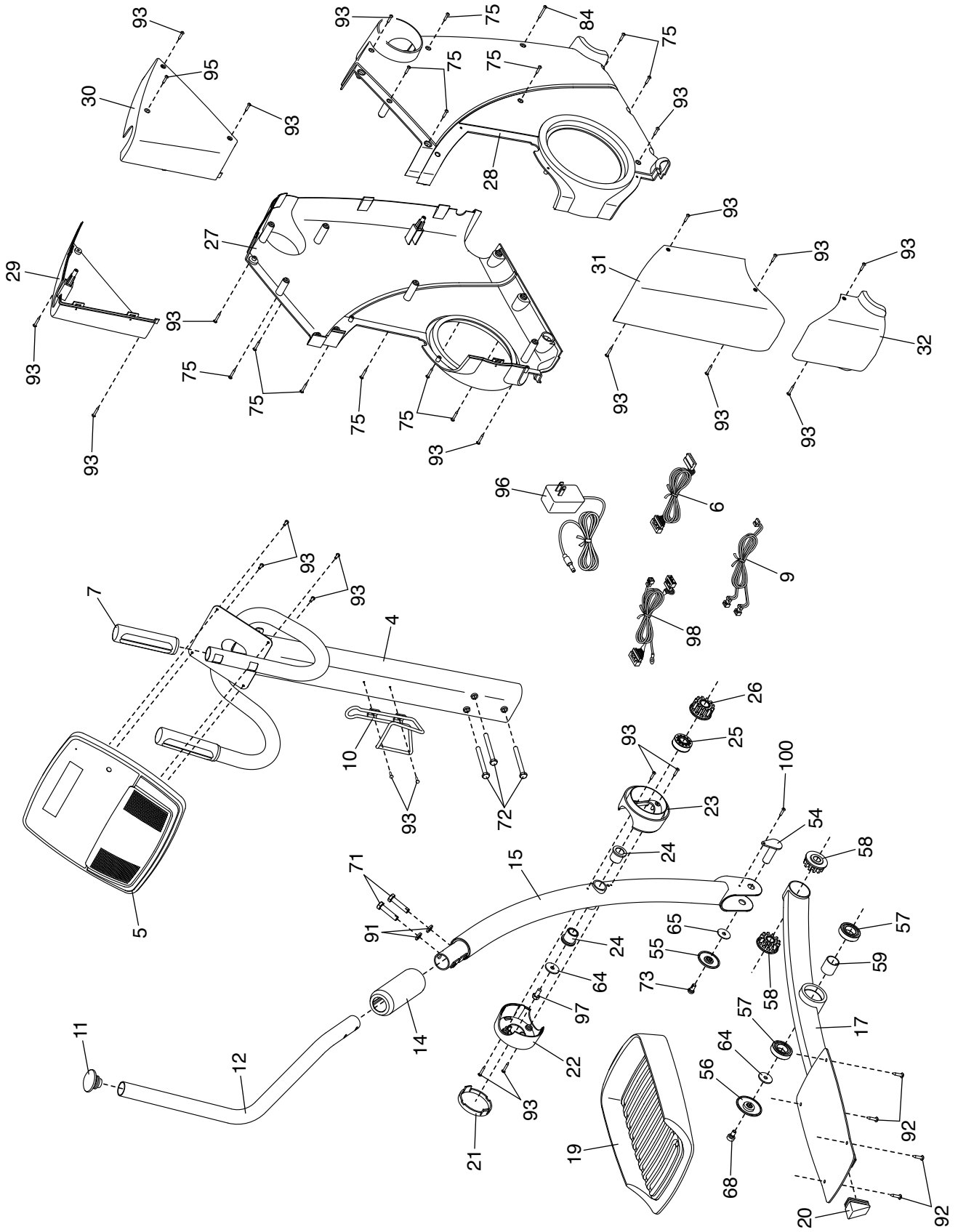

EXPLODED DRAWING B

Model No. PFEL05918.2 R0919A

