

EXPLODED DRAWING A

Model No. PFEL05918.3 R1119A

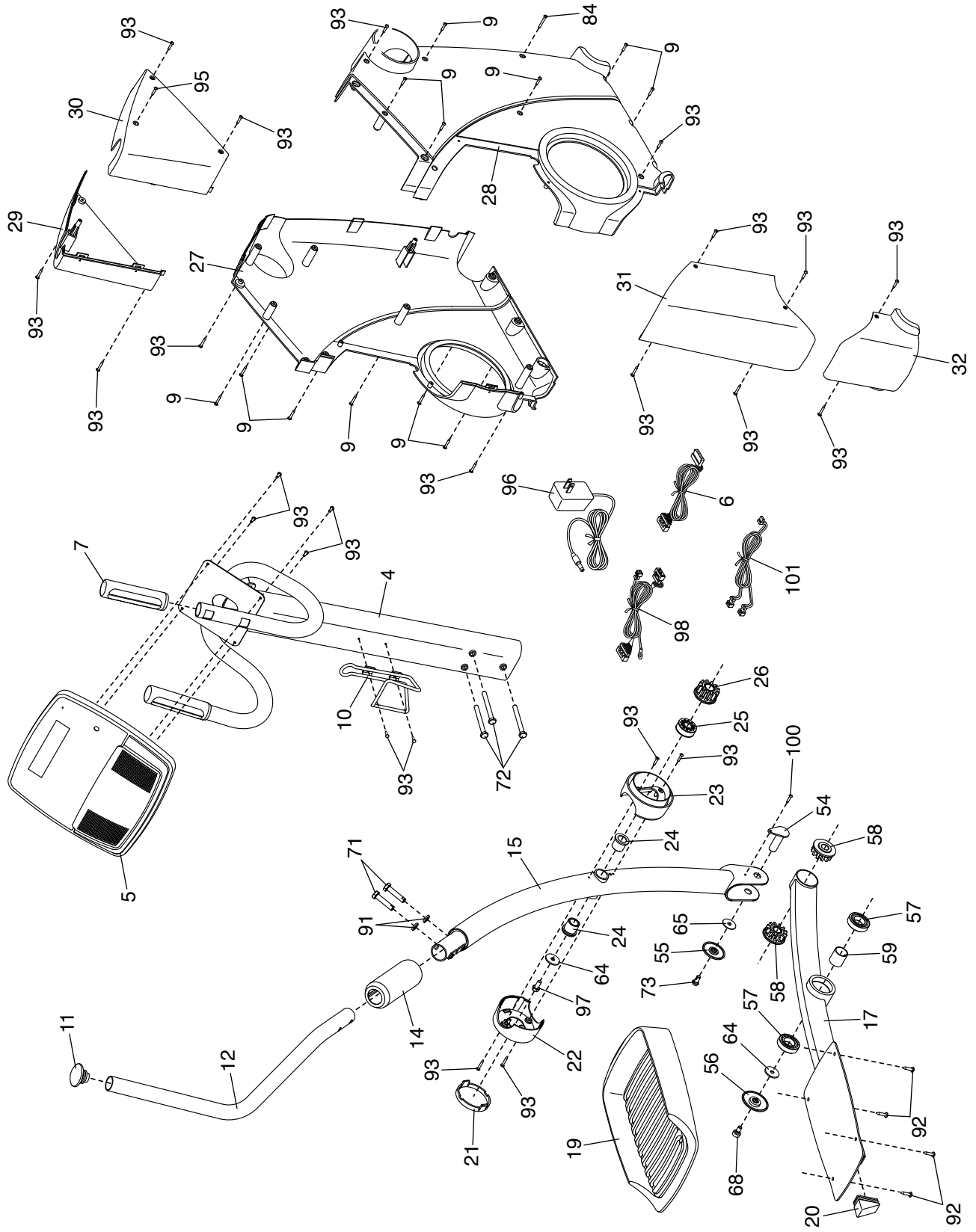

EXPLODED DRAWING B

Model No. PFEL05918.3 R1119A

