

EXPLODED DRAWING A

Model No. PFEL06611.0 R0911A

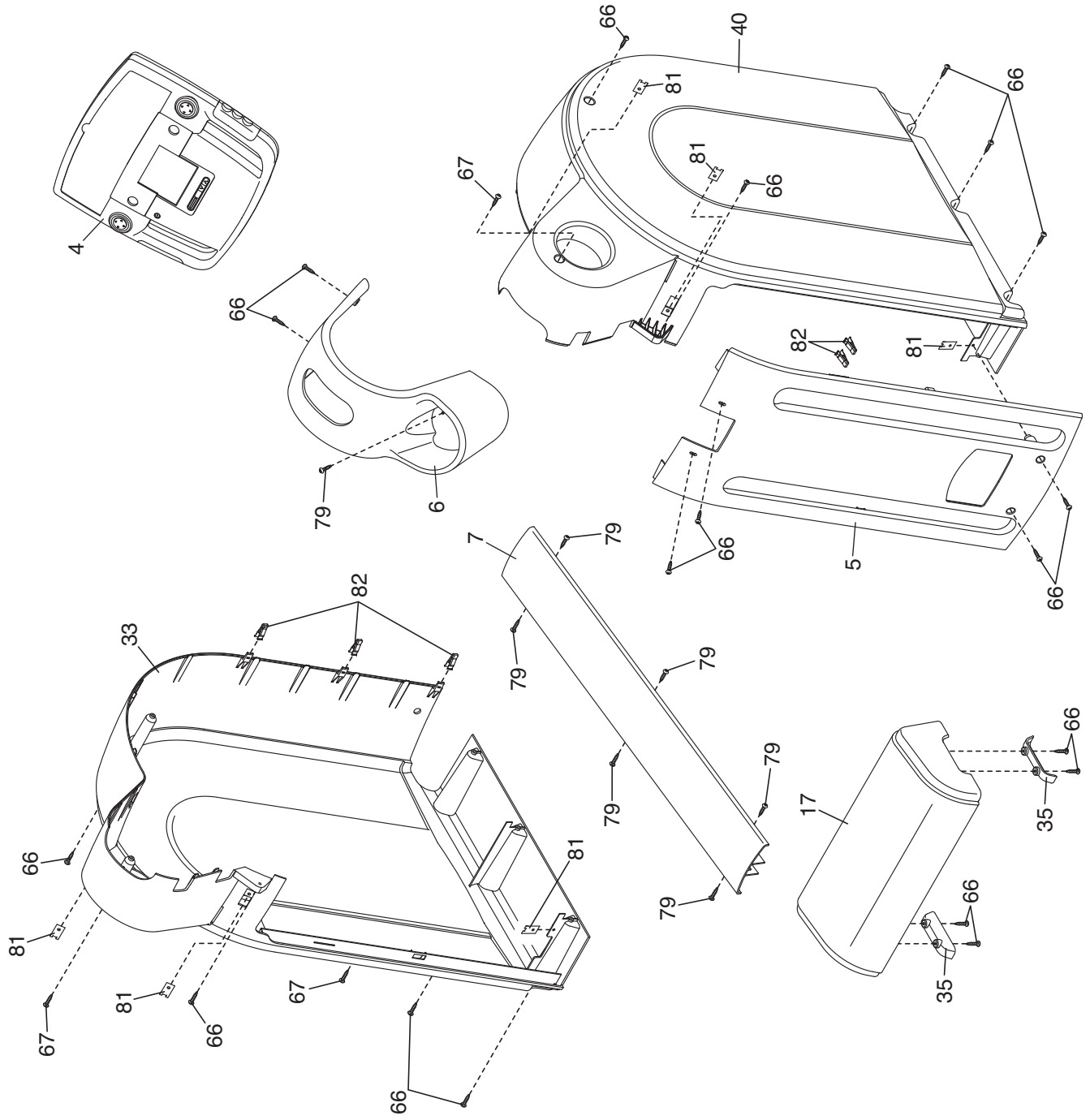

EXPLODED DRAWING B

Model No. PFEL06611.0 R0911A

