

EXPLODED DRAWING A

Model No. PFEL06916.2 R1217A

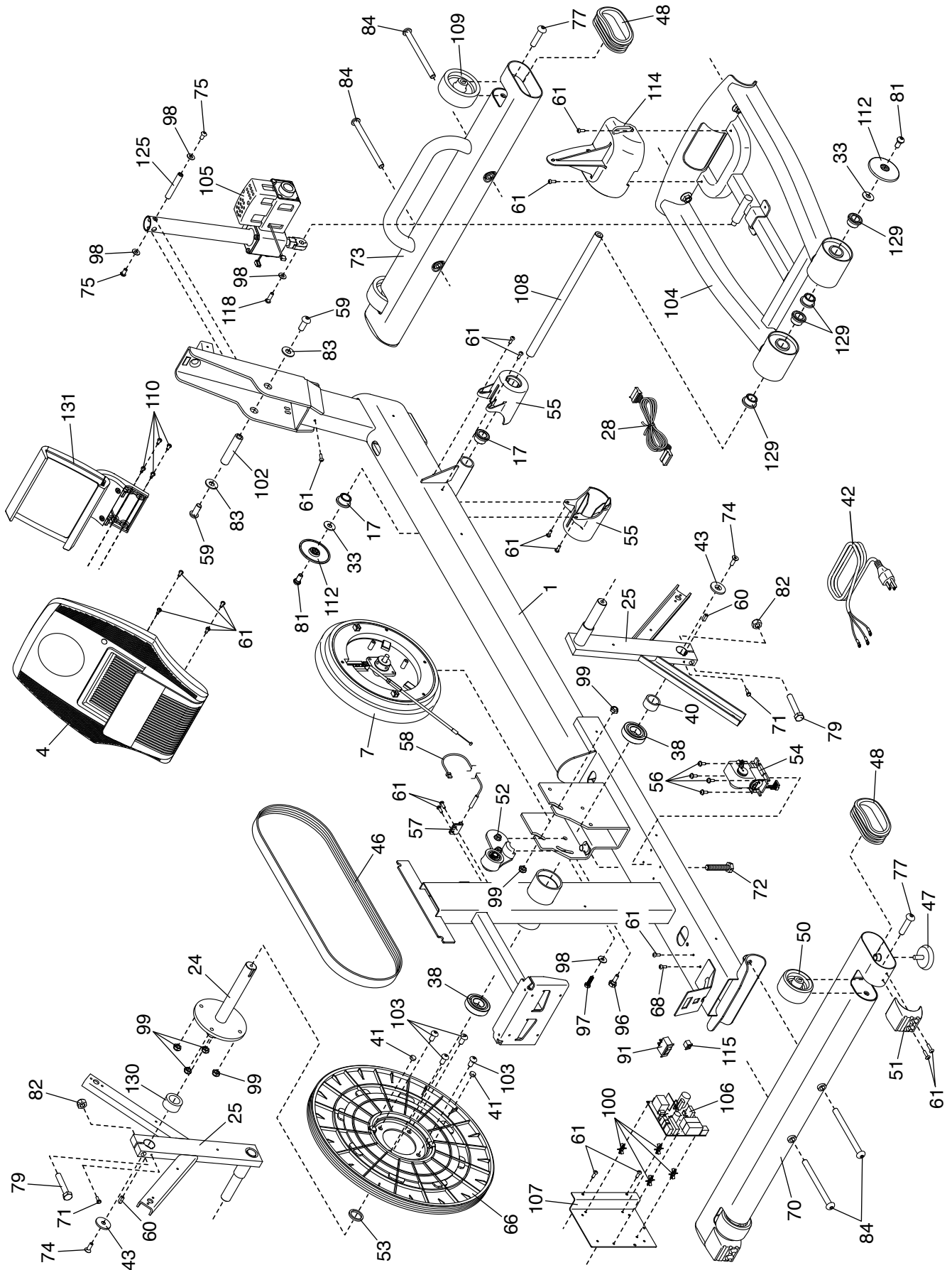

EXPLODED DRAWING B

Model No. PFEL06916.2 R1217A

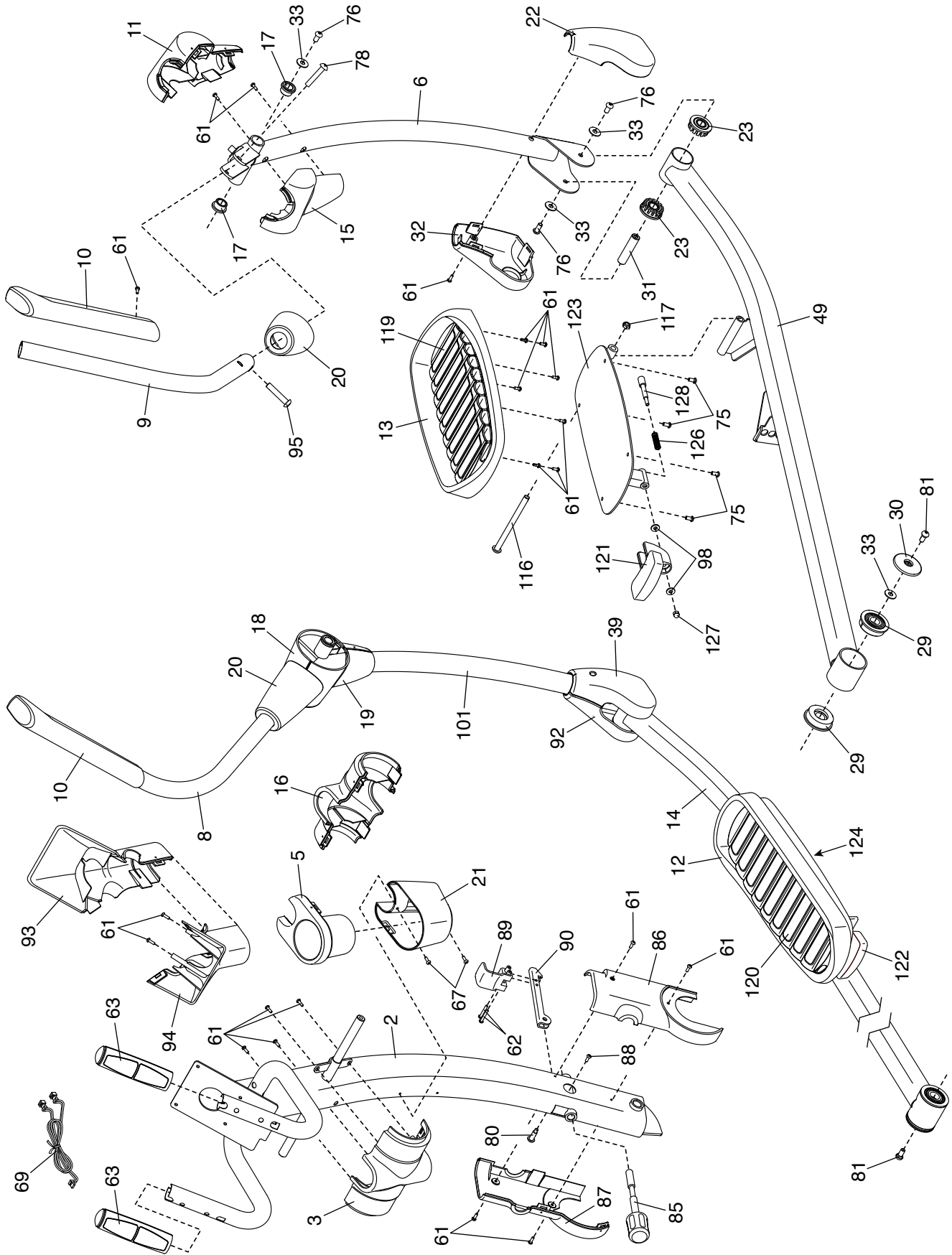

EXPLODED DRAWING C

Model No. PFEL06916.2 R1217A

