

# EXPLODED DRAWING A

Model No. PFEL07716.0 R1116A

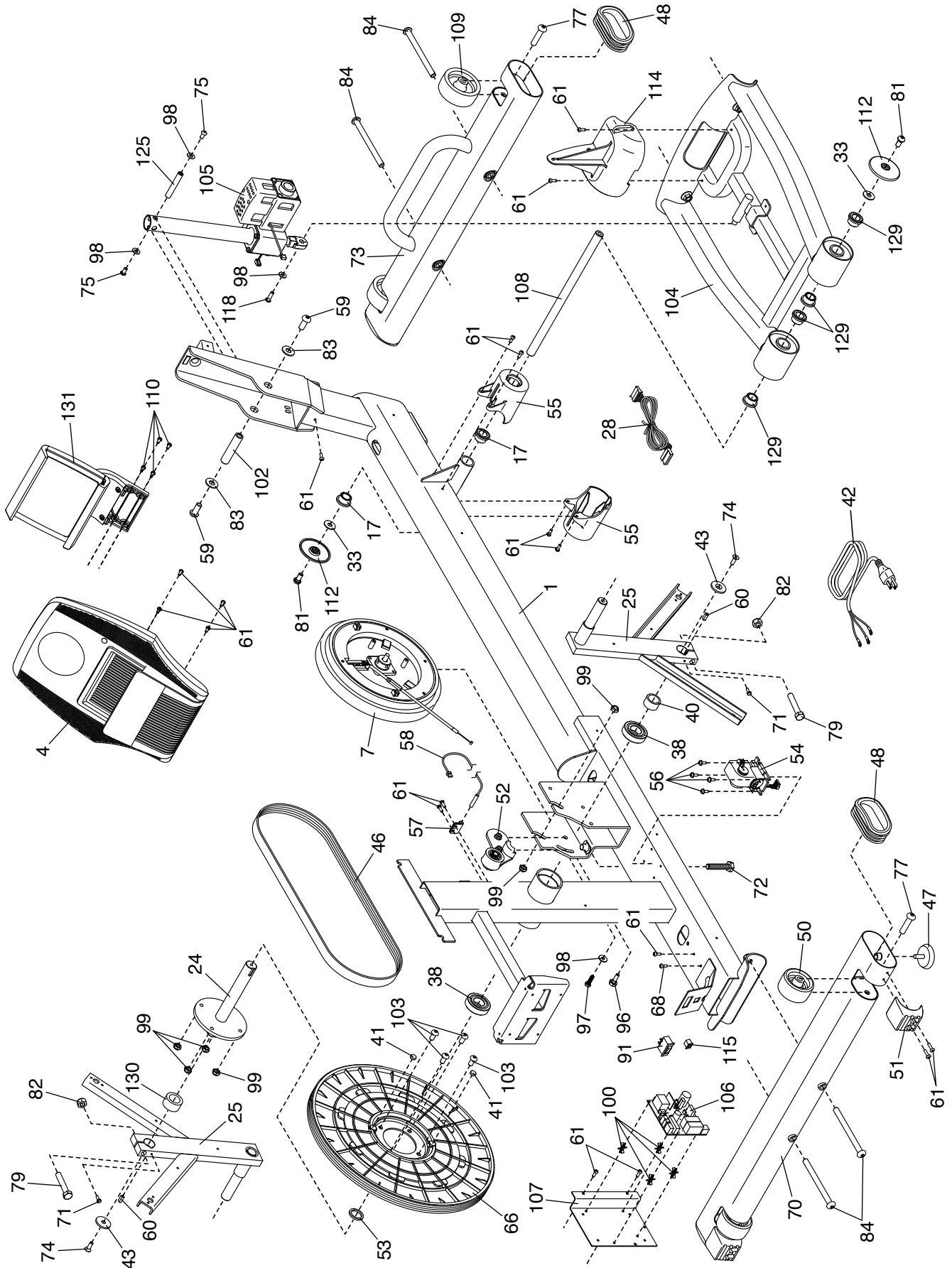

# EXPLODED DRAWING B

Model No. PFEL07716.0 R1116A

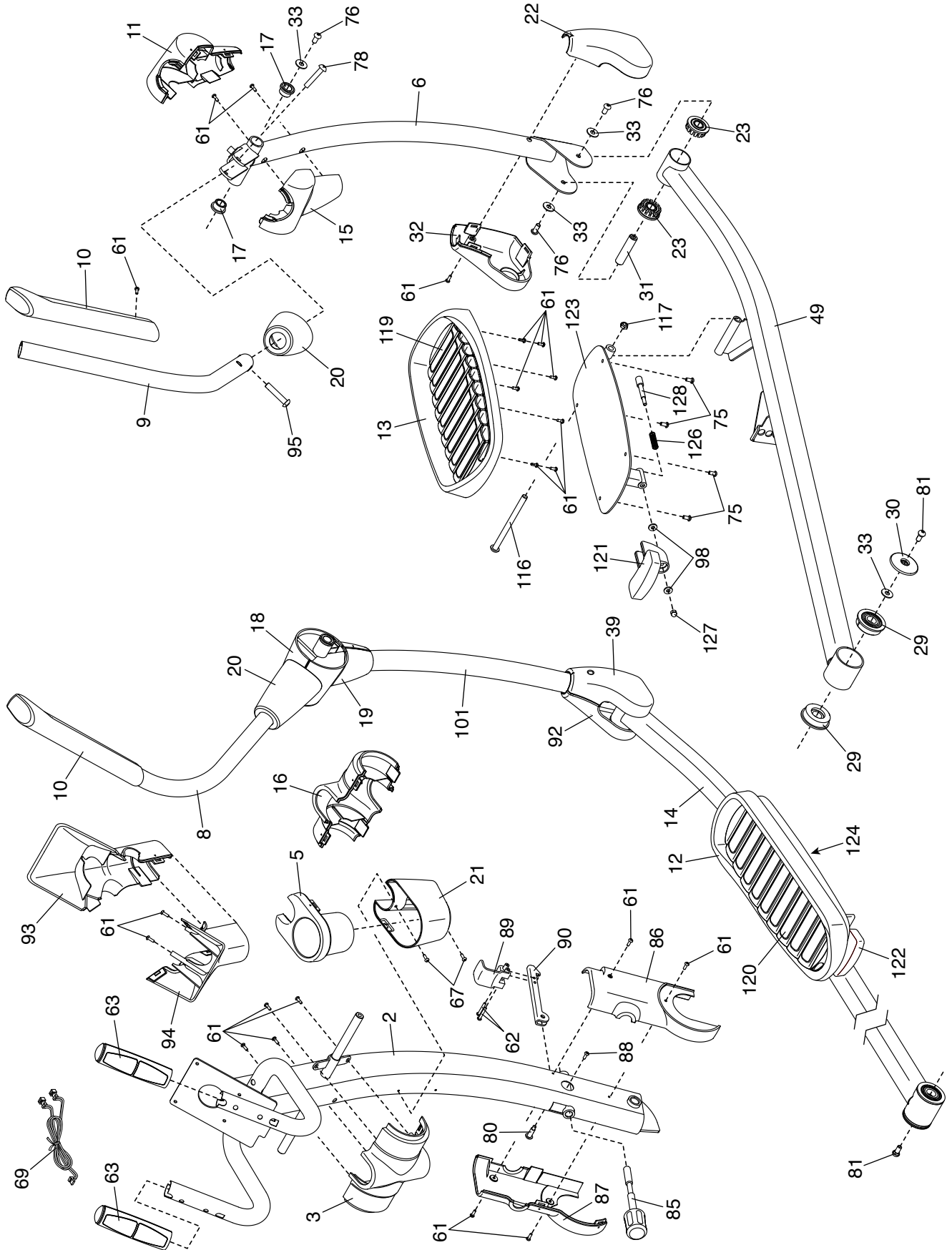

# EXPLODED DRAWING C

Model No. PFEL07716.0 R1116A

