

EXPLODED DRAWING A

Model No. PFEL07716.2 R1217A

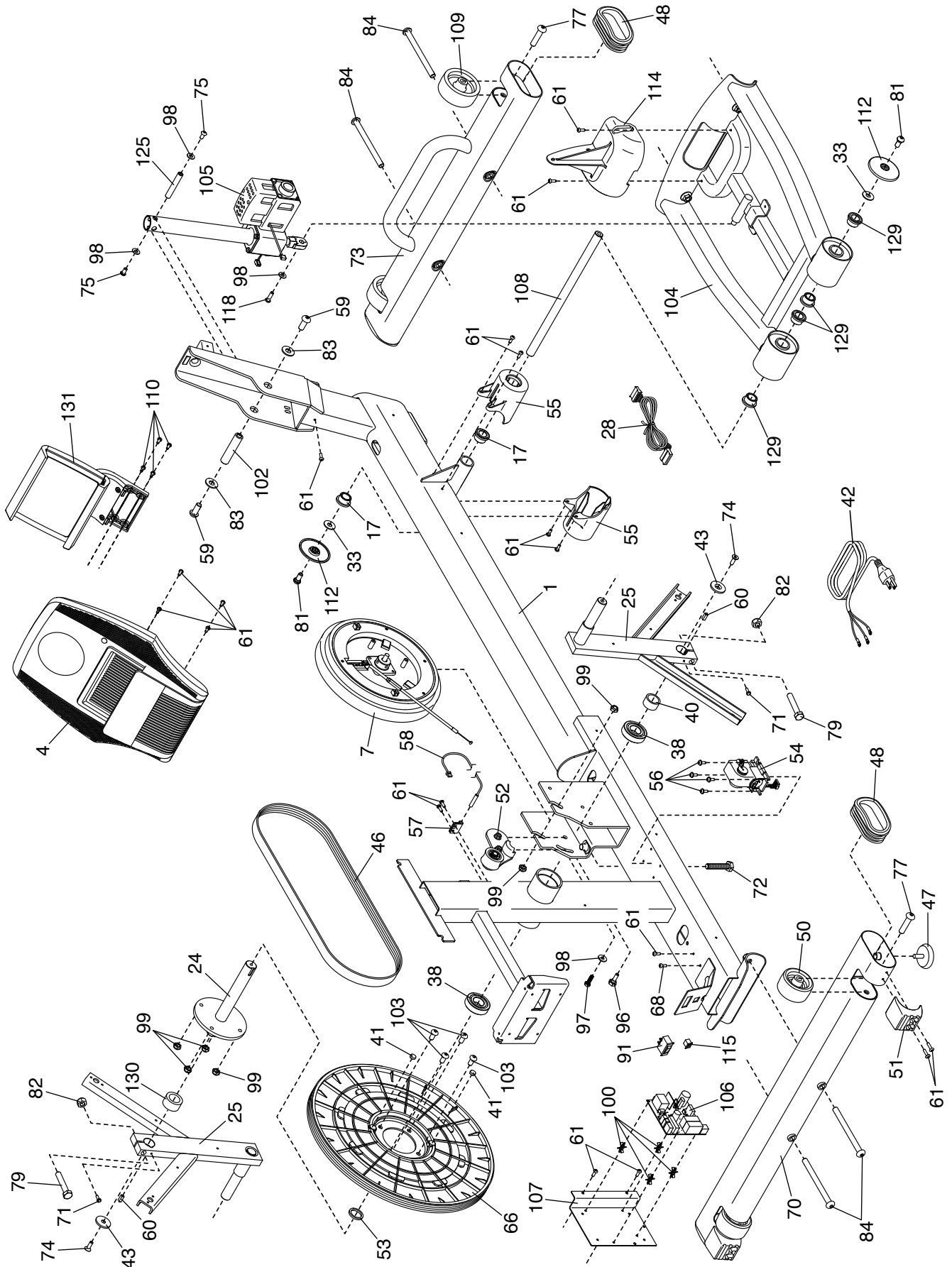

EXPLODED DRAWING B

Model No. PFEL07716.2 R1217A

