

EXPLODED DRAWING A

Model No. PFEL08011.2 R0412A

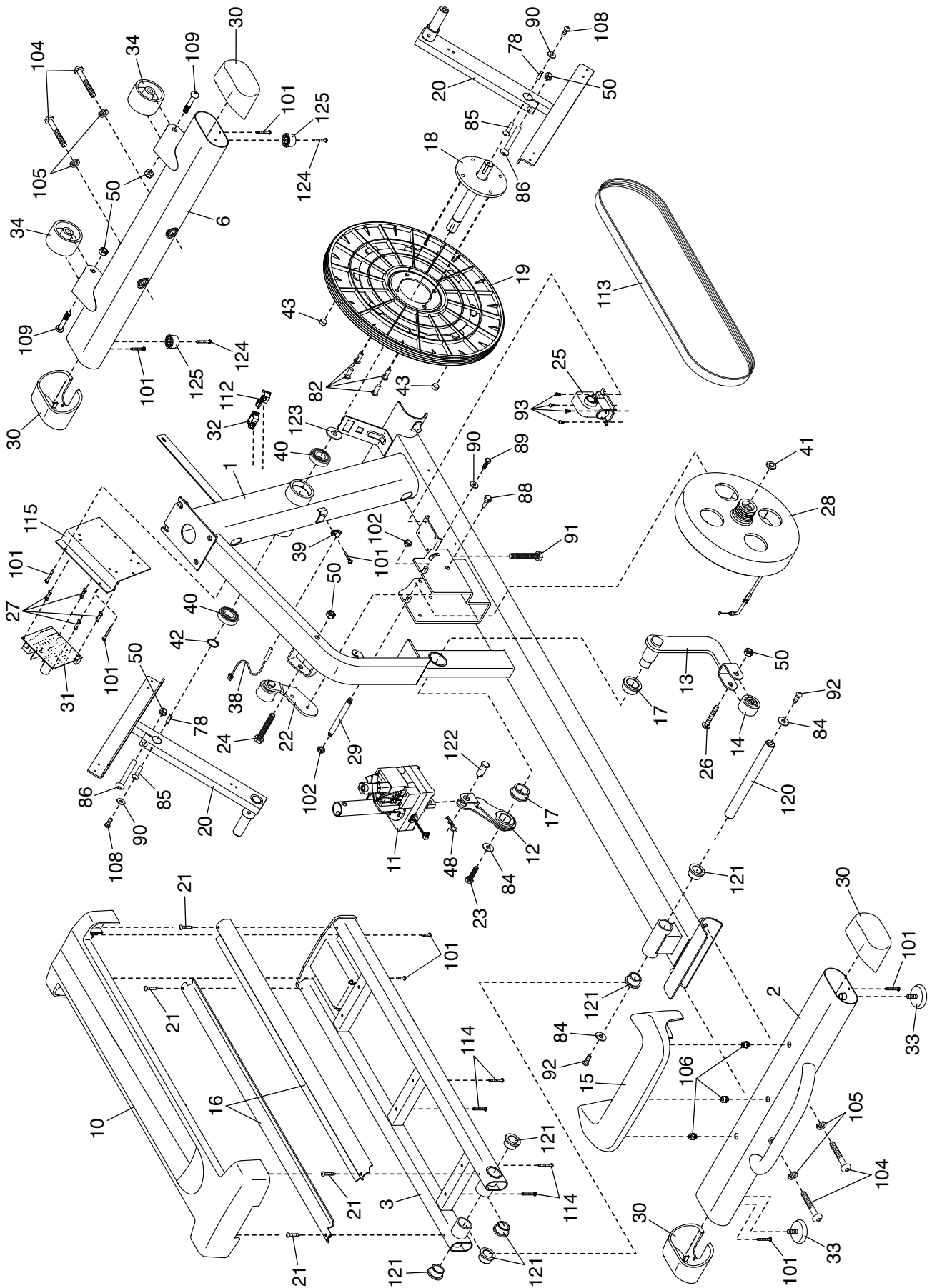

EXPLODED DRAWING B

Model No. PFEL08011.2 R0412A

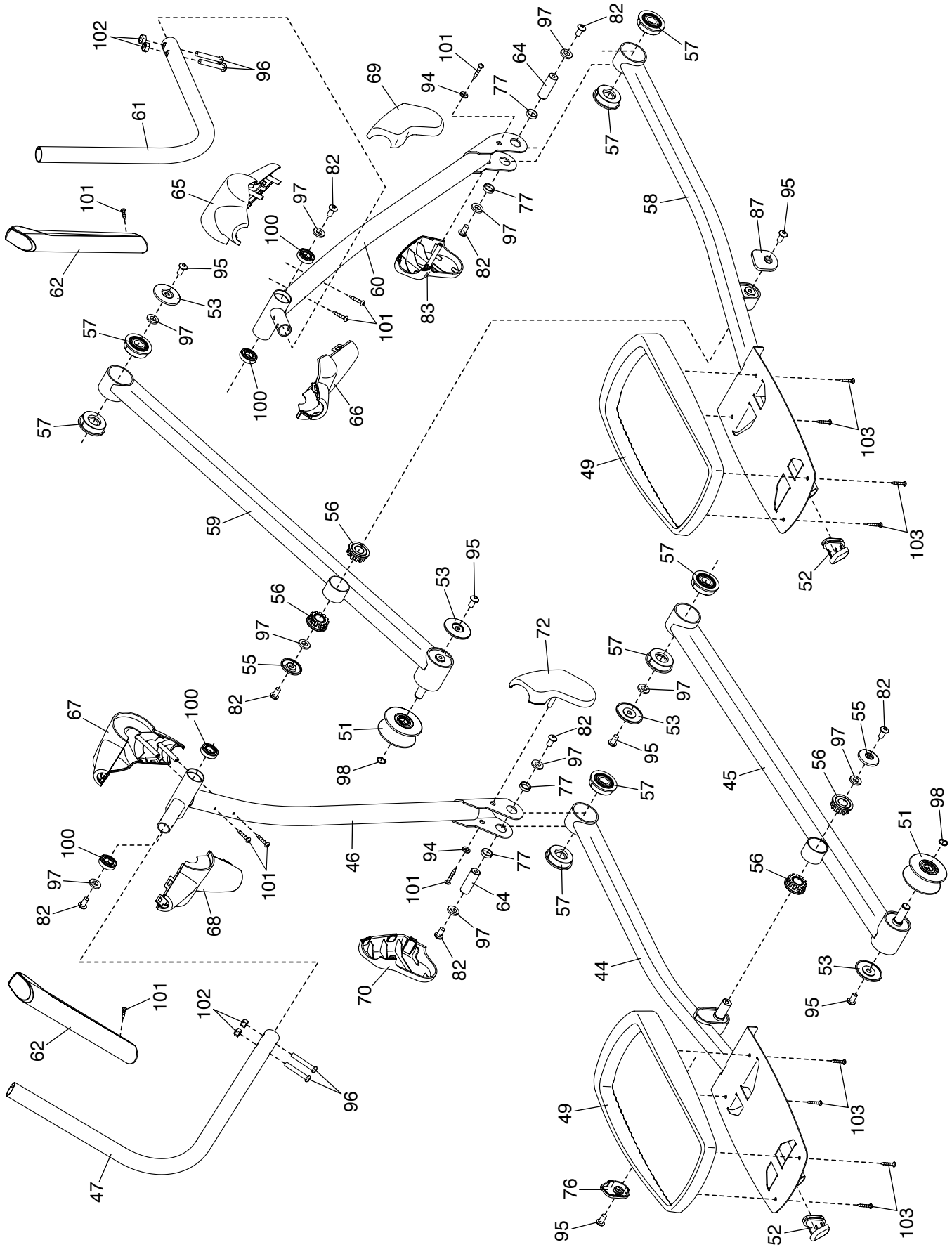

EXPLODED DRAWING C

Model No. PFEL08011.2 R0412A

