

EXPLODED DRAWING A

Model No. PFEL08011.6 R0414A

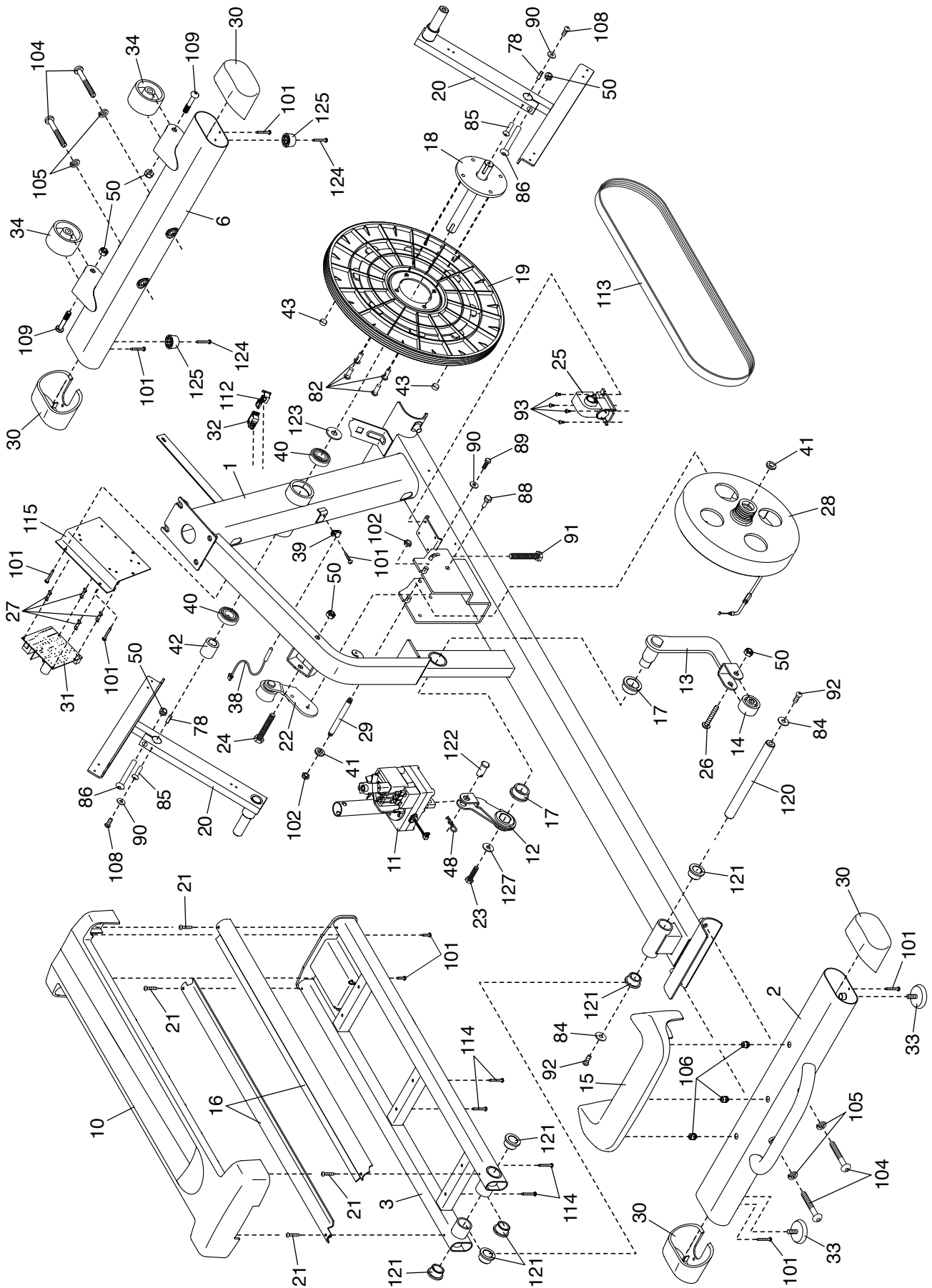

EXPLODED DRAWING B

Model No. PFEL08011.6 R0414A

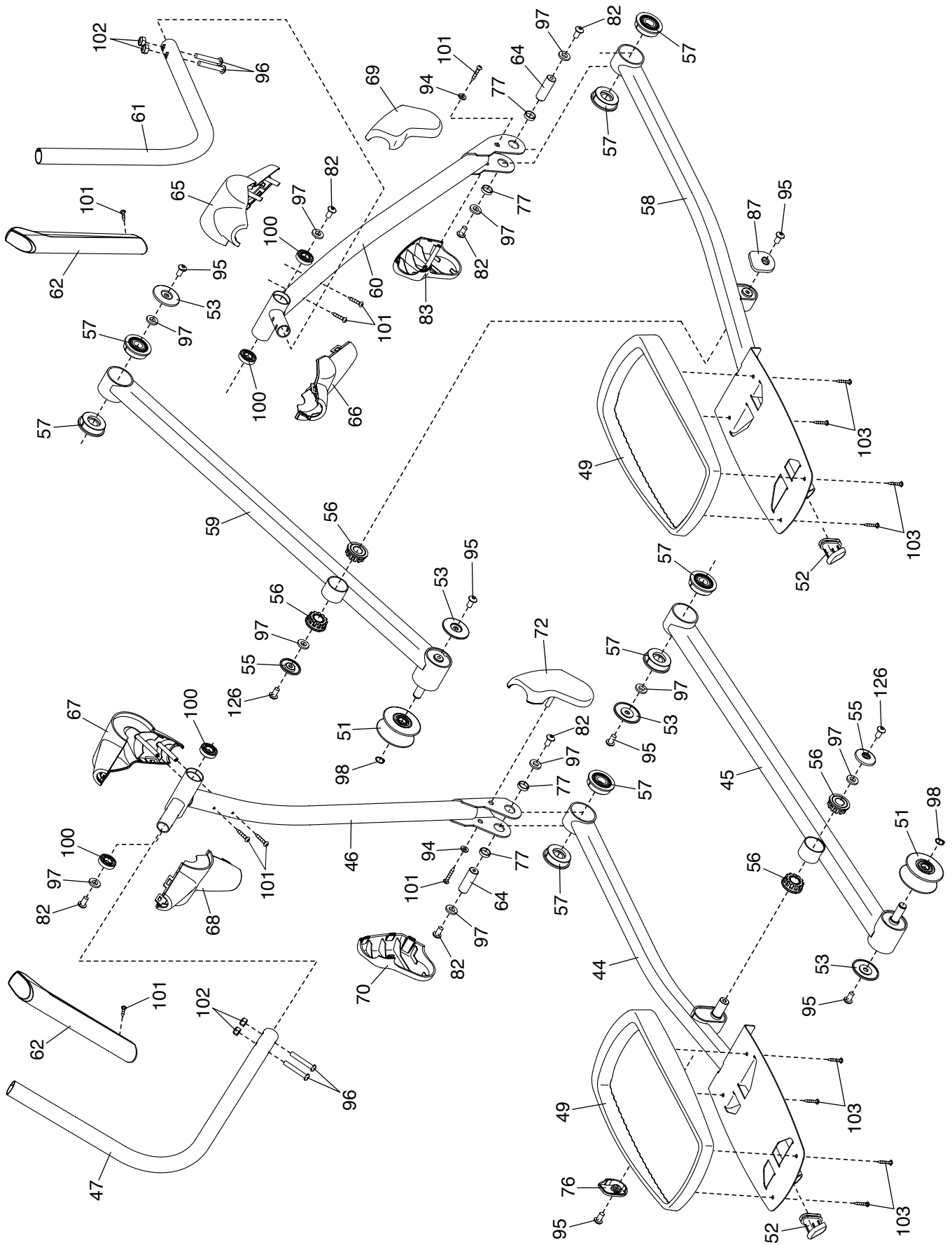

EXPLODED DRAWING C

Model No. PFEL08011.6 R0414A

