

EXPLODED DRAWING A

Model No. PFEL08916.2 R0118B

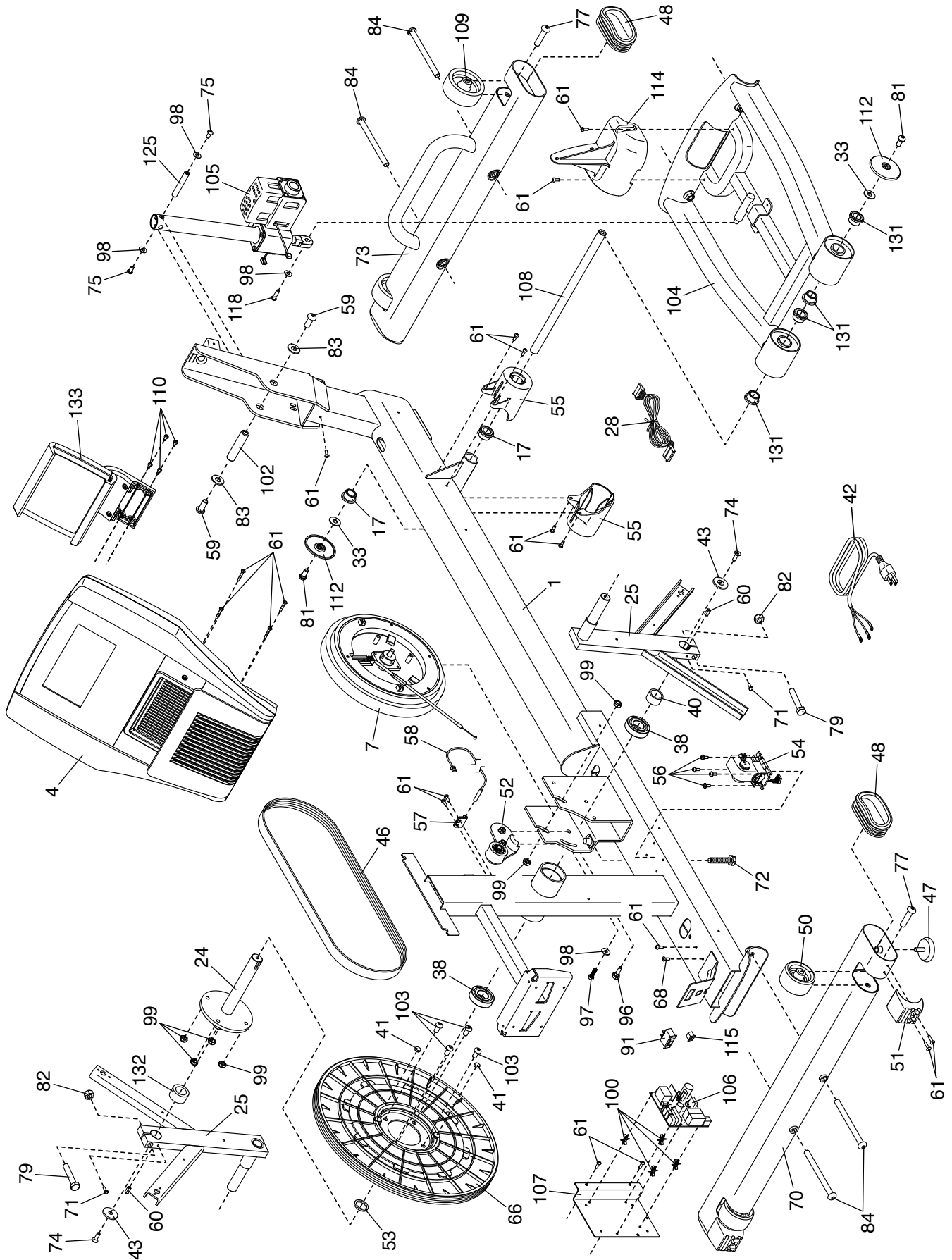

EXPLODED DRAWING B

Model No. PFEL08916.2 R0118B

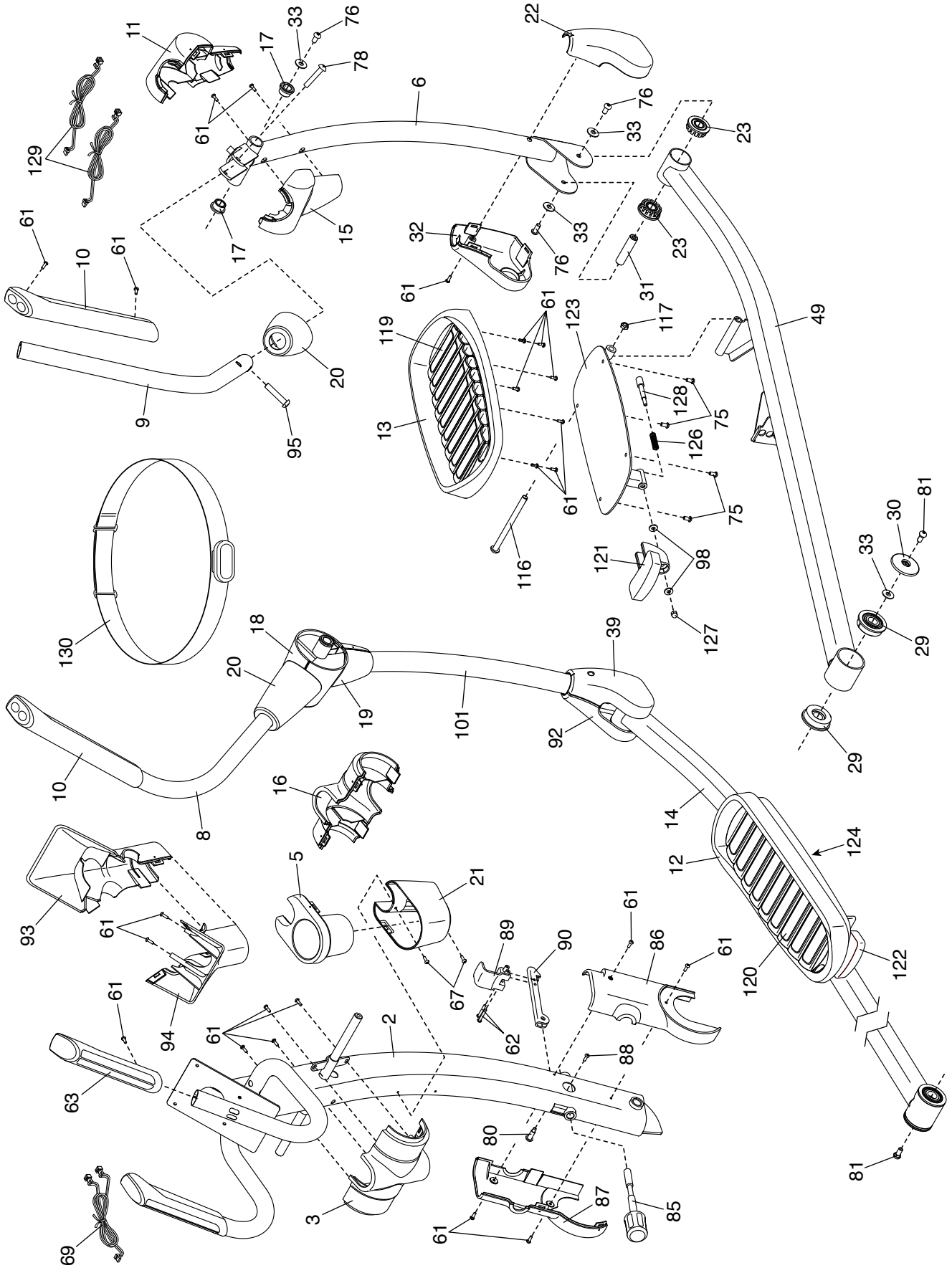

EXPLODED DRAWING C

Model No. PFEL08916.2 R0118B

