

EXPLODED DRAWING A

Model No. PFEL09009.1 R1110A

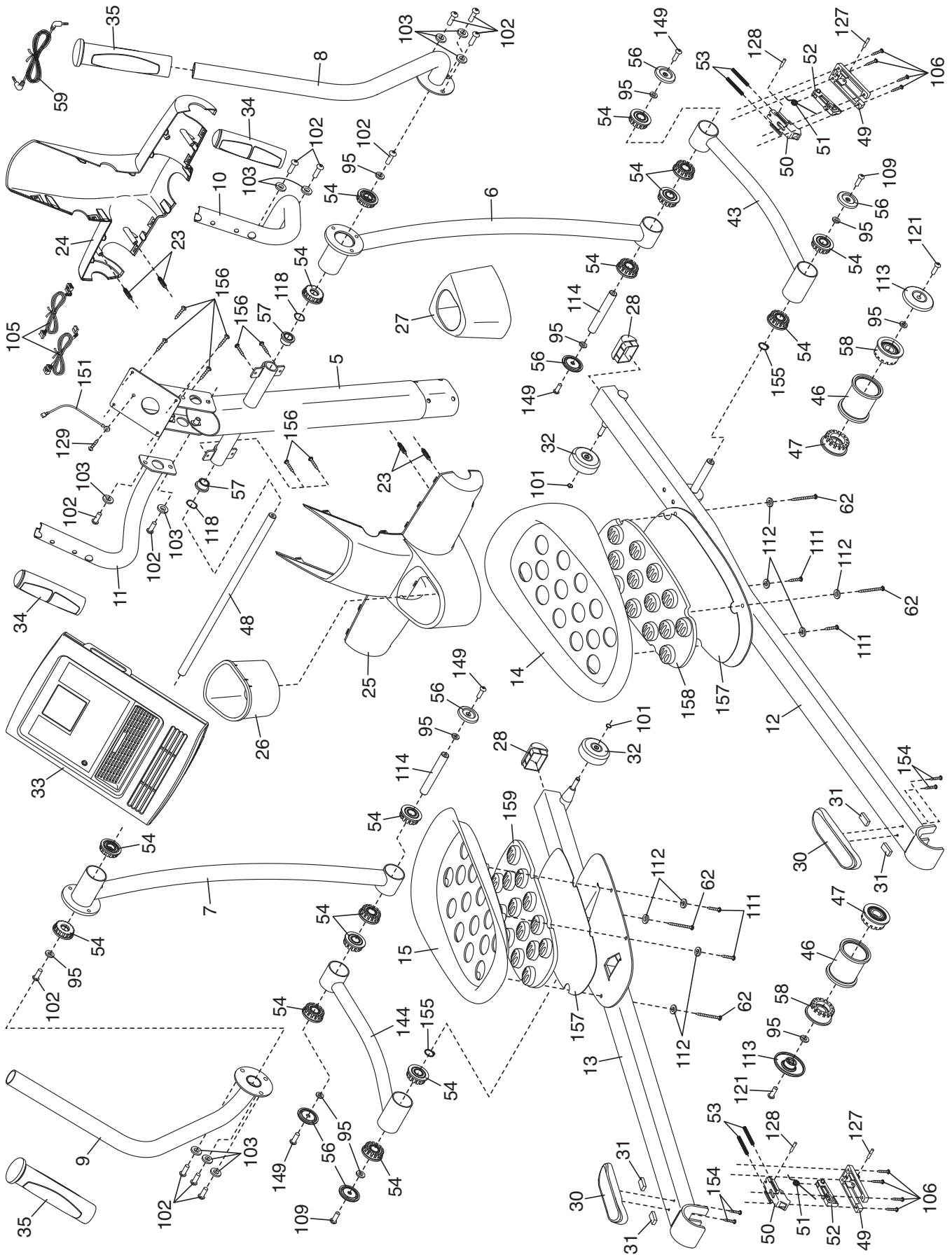

EXPLODED DRAWING B

Model No. PFEL09009.1 R1110A

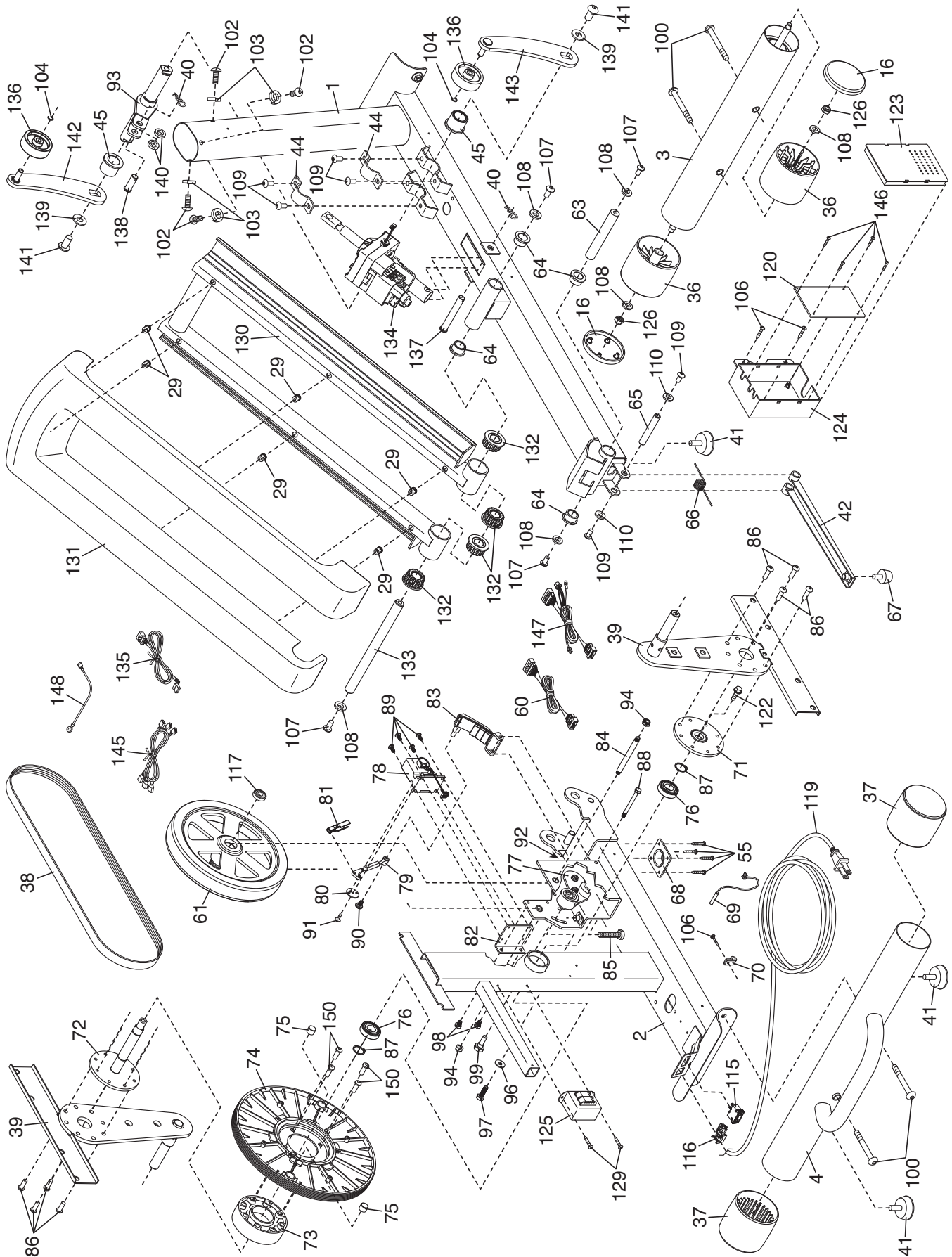

EXPLODED DRAWING C

Model No. PFEL09009.1 R1110A

