

EXPLODED DRAWING A

Model No. PFEL09009.2 R0111A

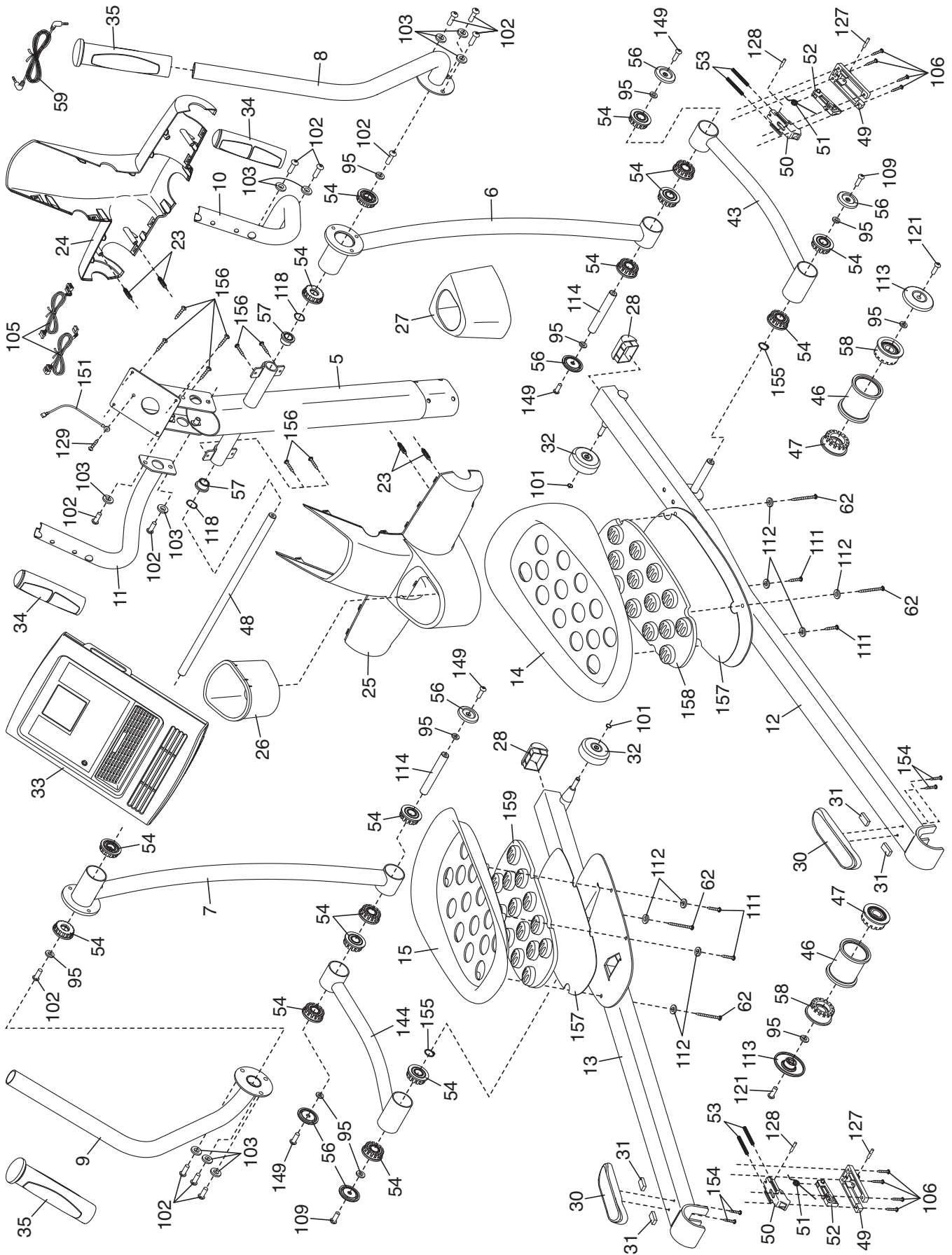

EXPLODED DRAWING B

Model No. PFEL09009.2 R0111A

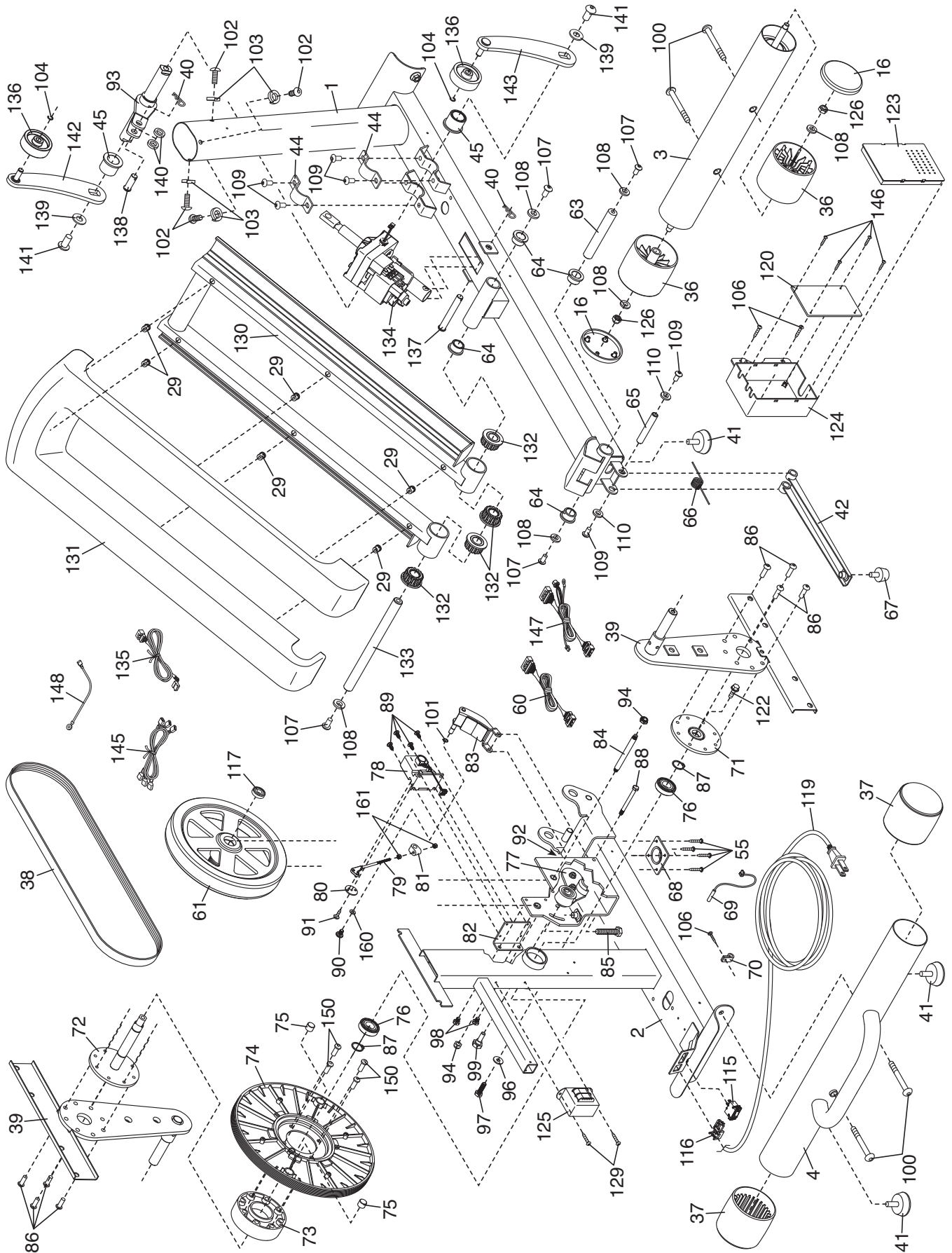

EXPLODED DRAWING C

Model No. PFEL09009.2 R0111A

