

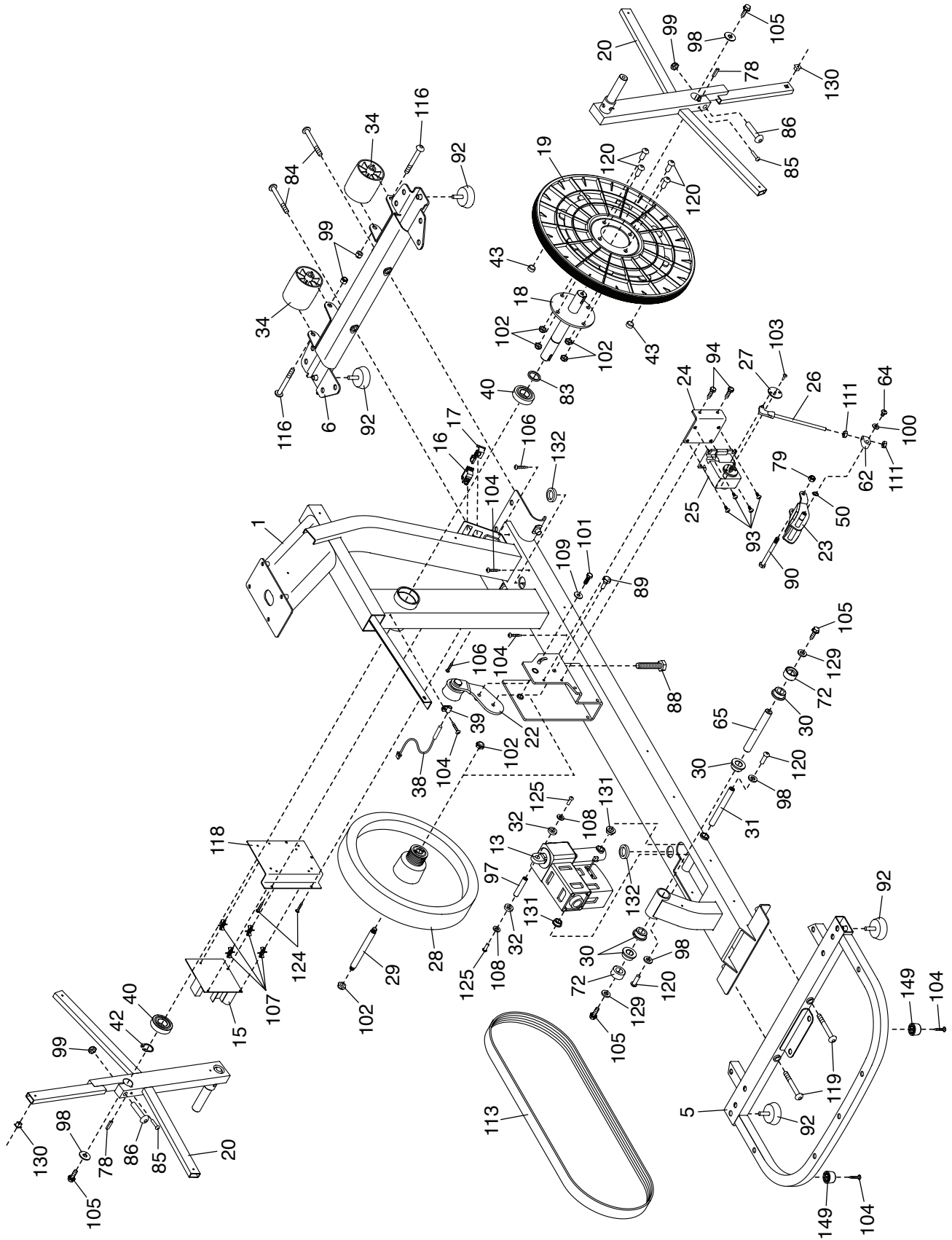

# EXPLODED DRAWING B

Model No. PFEL09911.2 R1112A



# EXPLODED DRAWING C

Model No. PFEL09911.2 R1112A

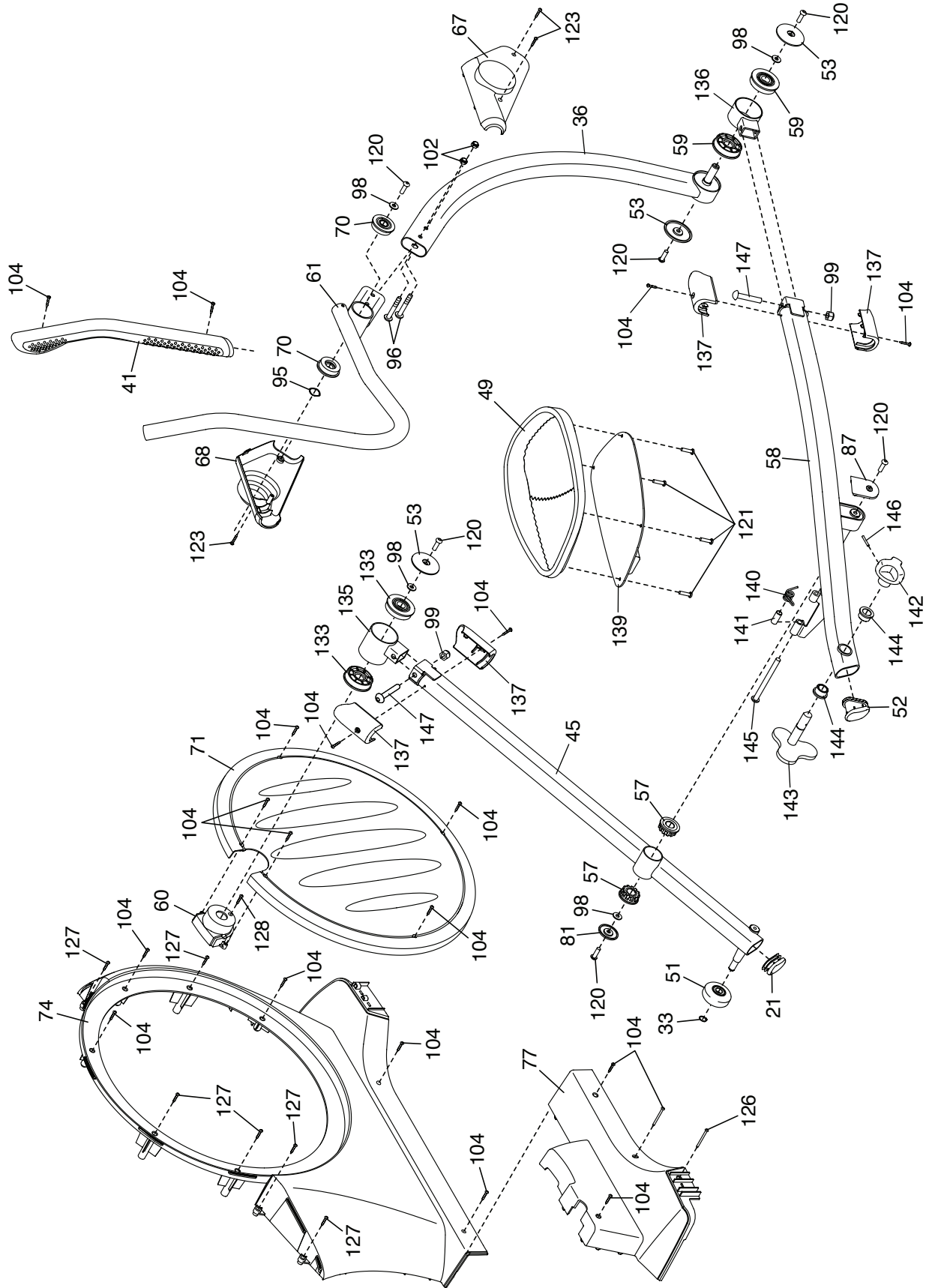

# EXPLODED DRAWING D

Model No. PFEL09911.2 R1112A

