

EXPLODED DRAWING A

Model No. PFEL10112.3 R0515A

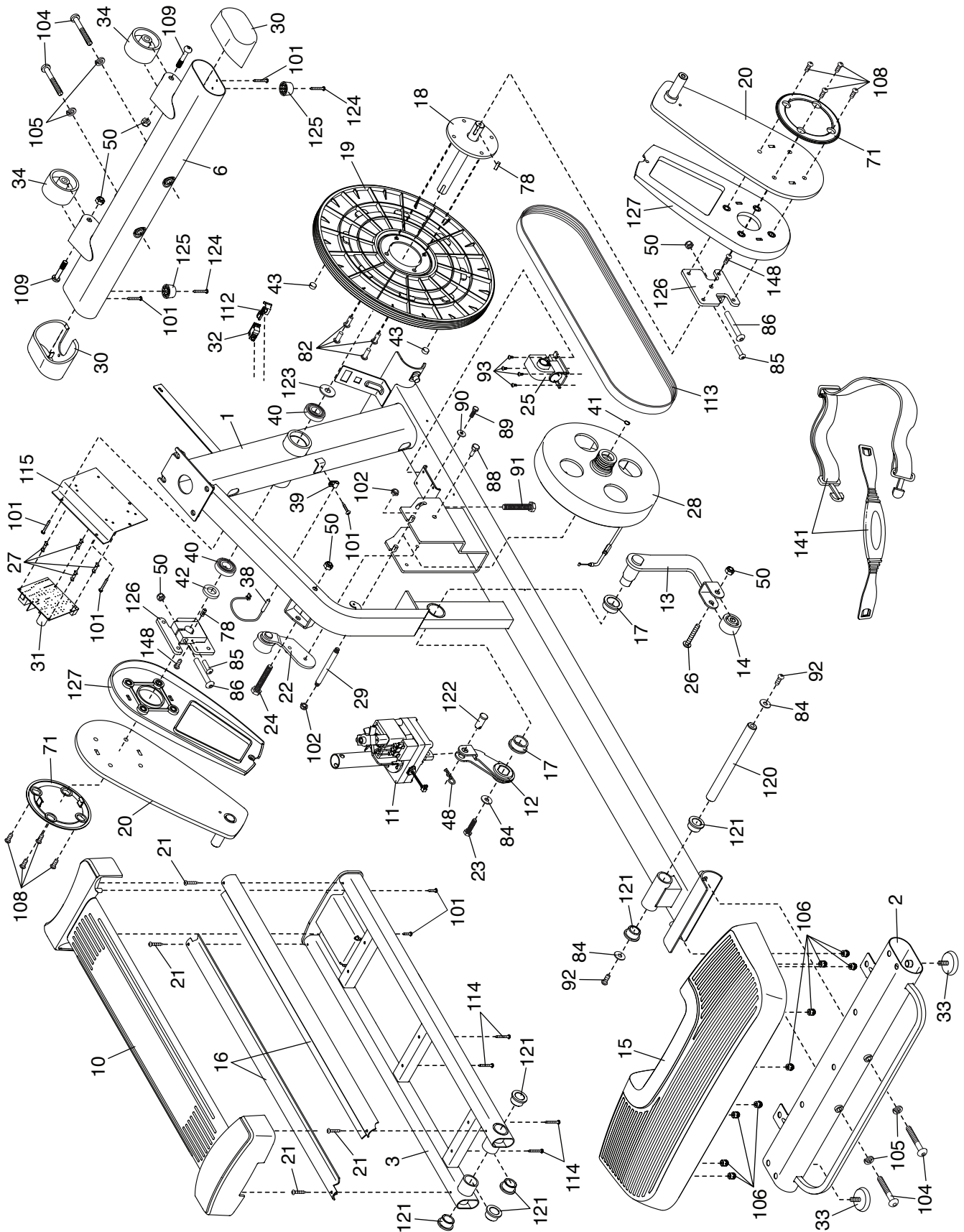

EXPLODED DRAWING C

Model No. PFEL10112.3 R0515A

