

EXPLODED DRAWING A

Model No. PFEL10112.0 R0113A

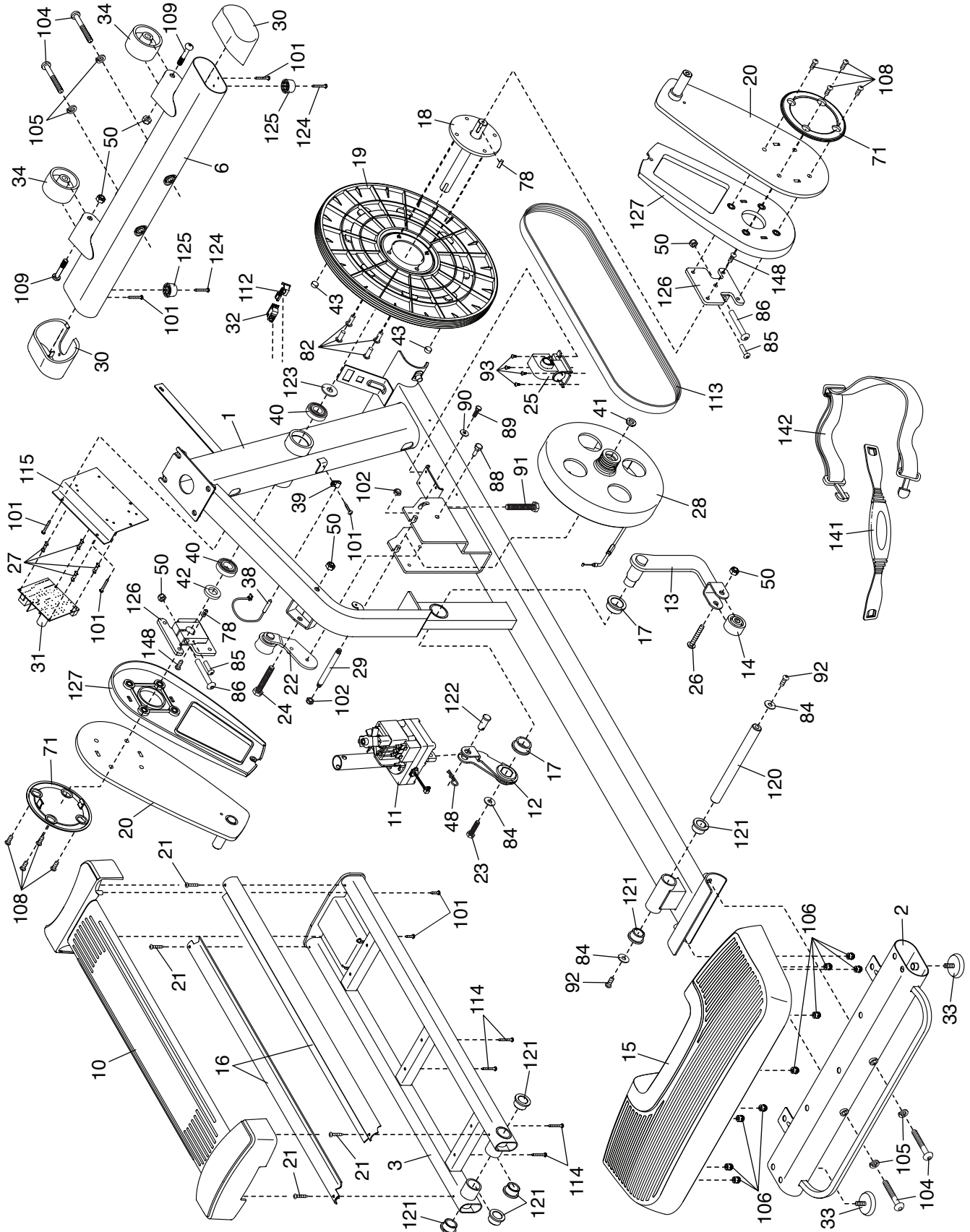

EXPLODED DRAWING B

Model No. PFEL10112.0 R0113A

