

EXPLODED DRAWING A—Model No. PFEL18010.1

R1010A

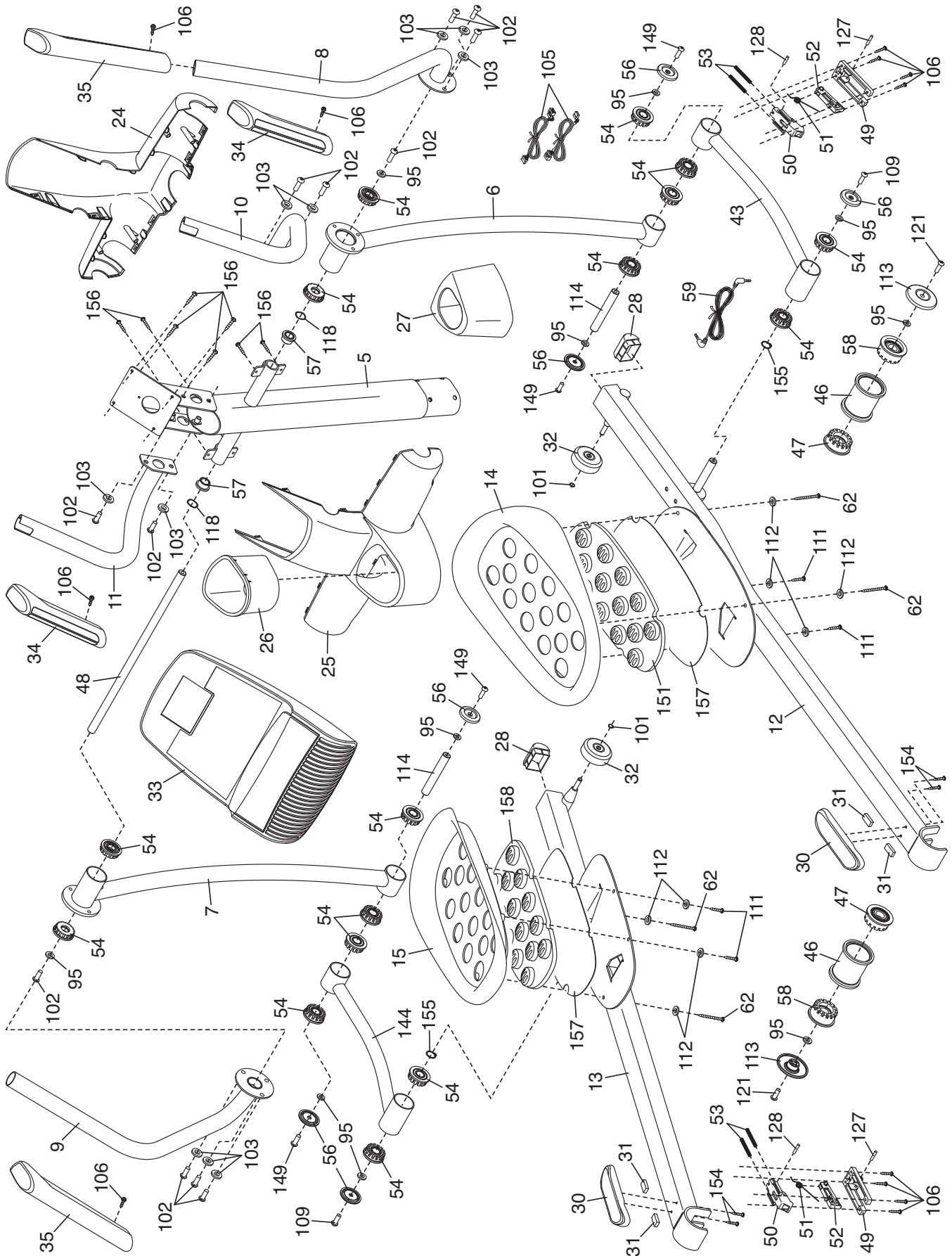

EXPLODED DRAWING B—Model No. PFEL18010.1

R1010A

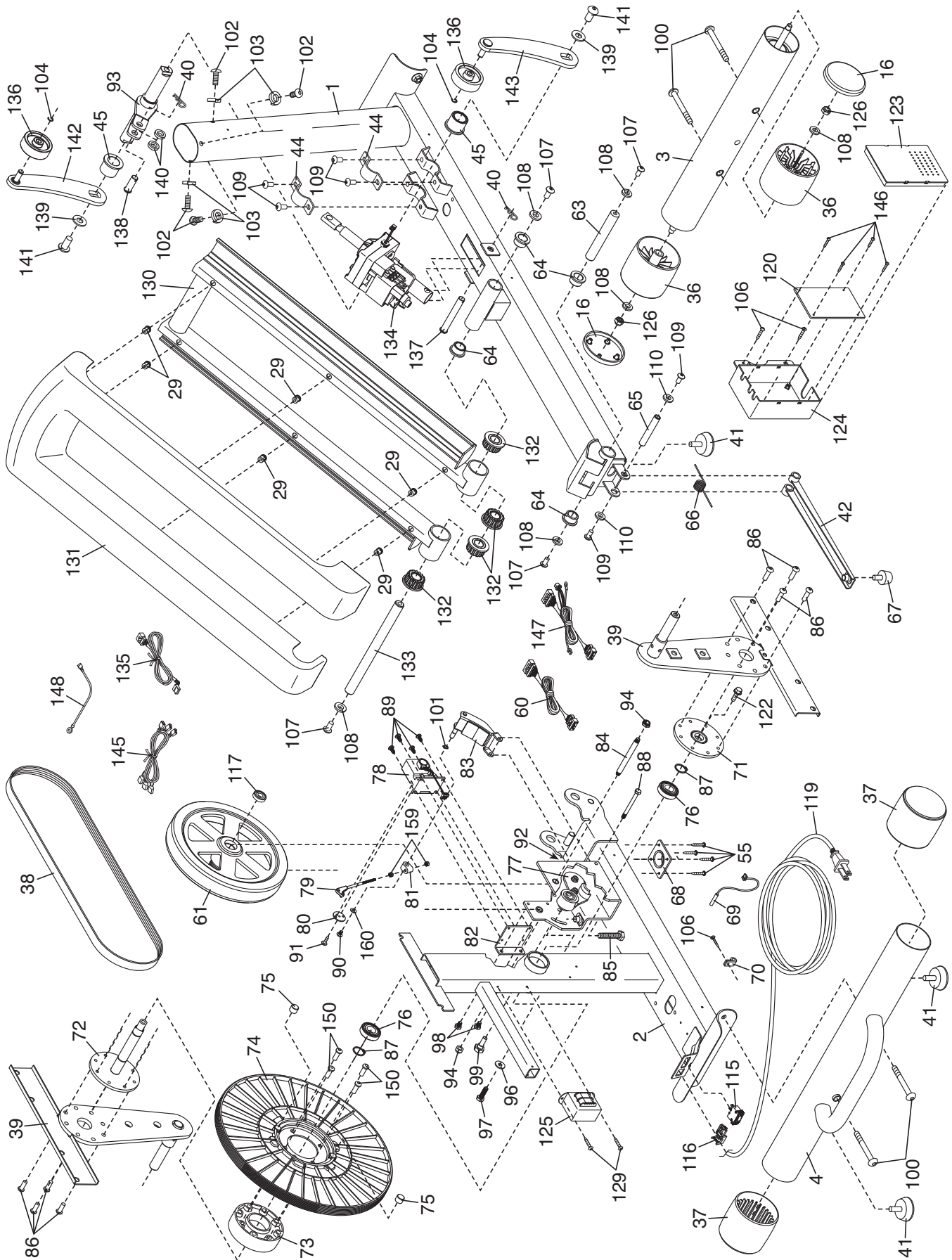

EXPLODED DRAWING C—Model No. PFEL18010.1

R1010A

