

EXPLODED DRAWING A

Model No. PFEL18010.6 R0512A

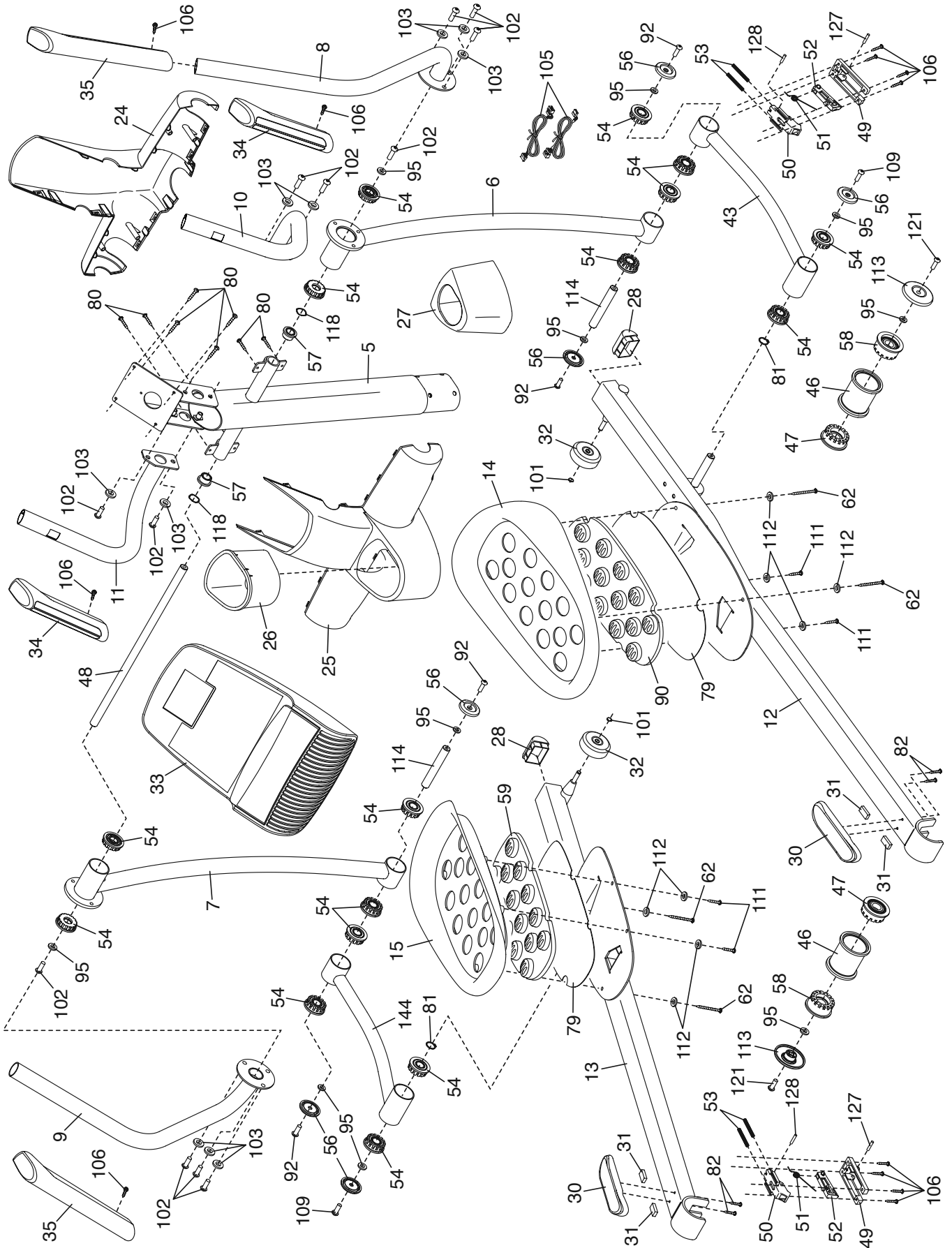

EXPLODED DRAWING B

Model No. PFEL18010.6 R0512A

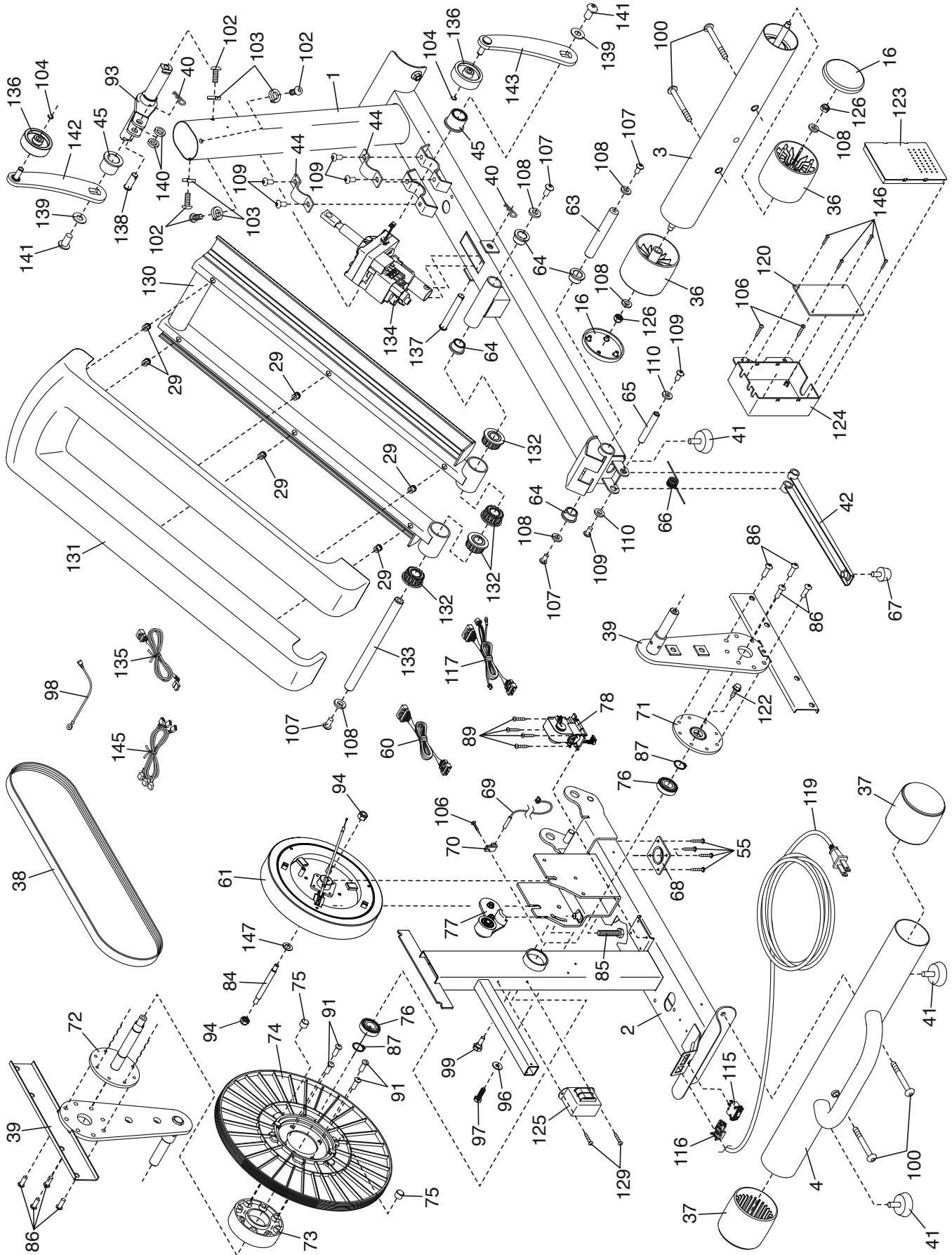

EXPLODED DRAWING C

Model No. PFEL18010.6 R0512A

