

EXPLODED DRAWING A

Model No. PFEL18010.7 R1213A

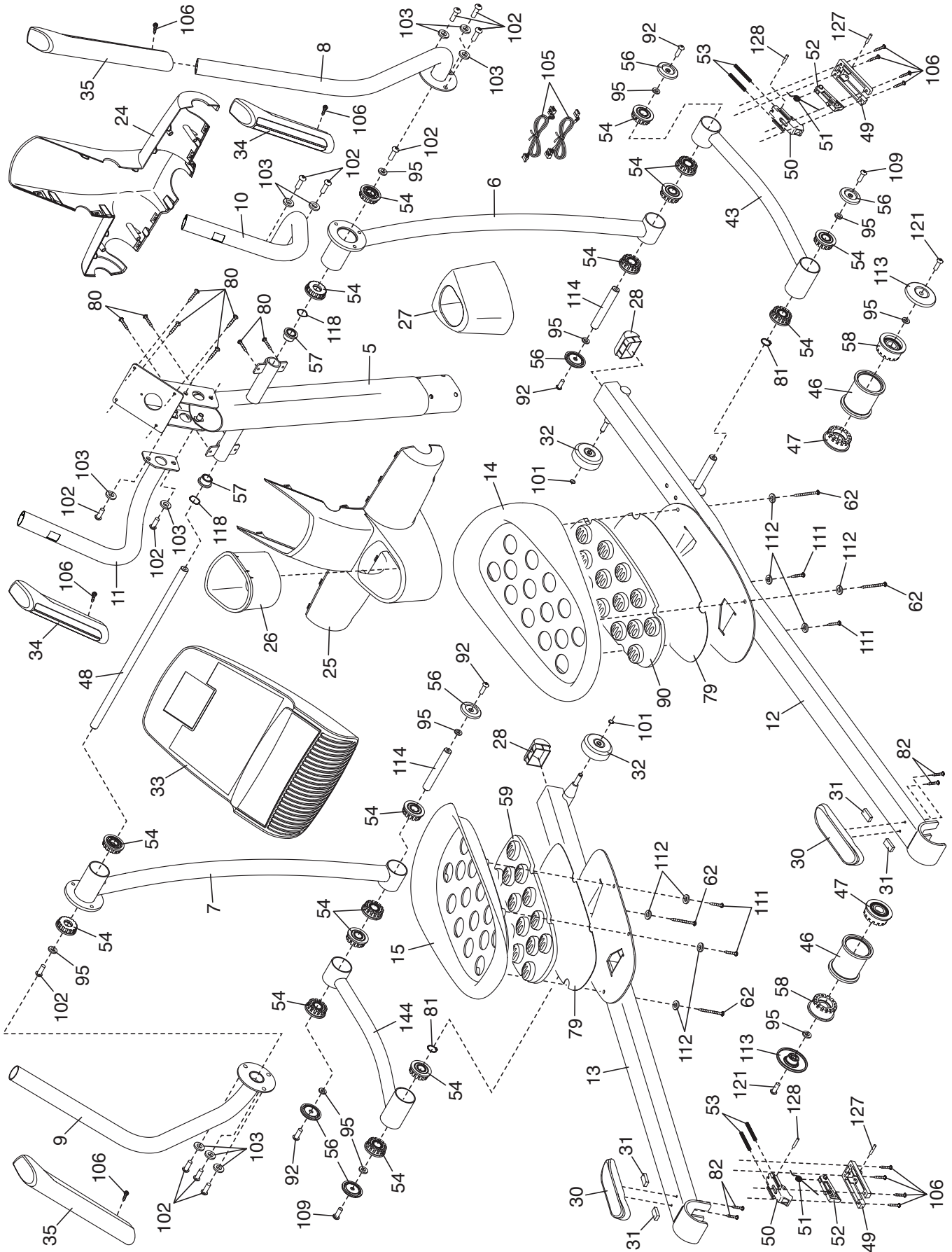

EXPLODED DRAWING B

Model No. PFEL18010.7 R1213A

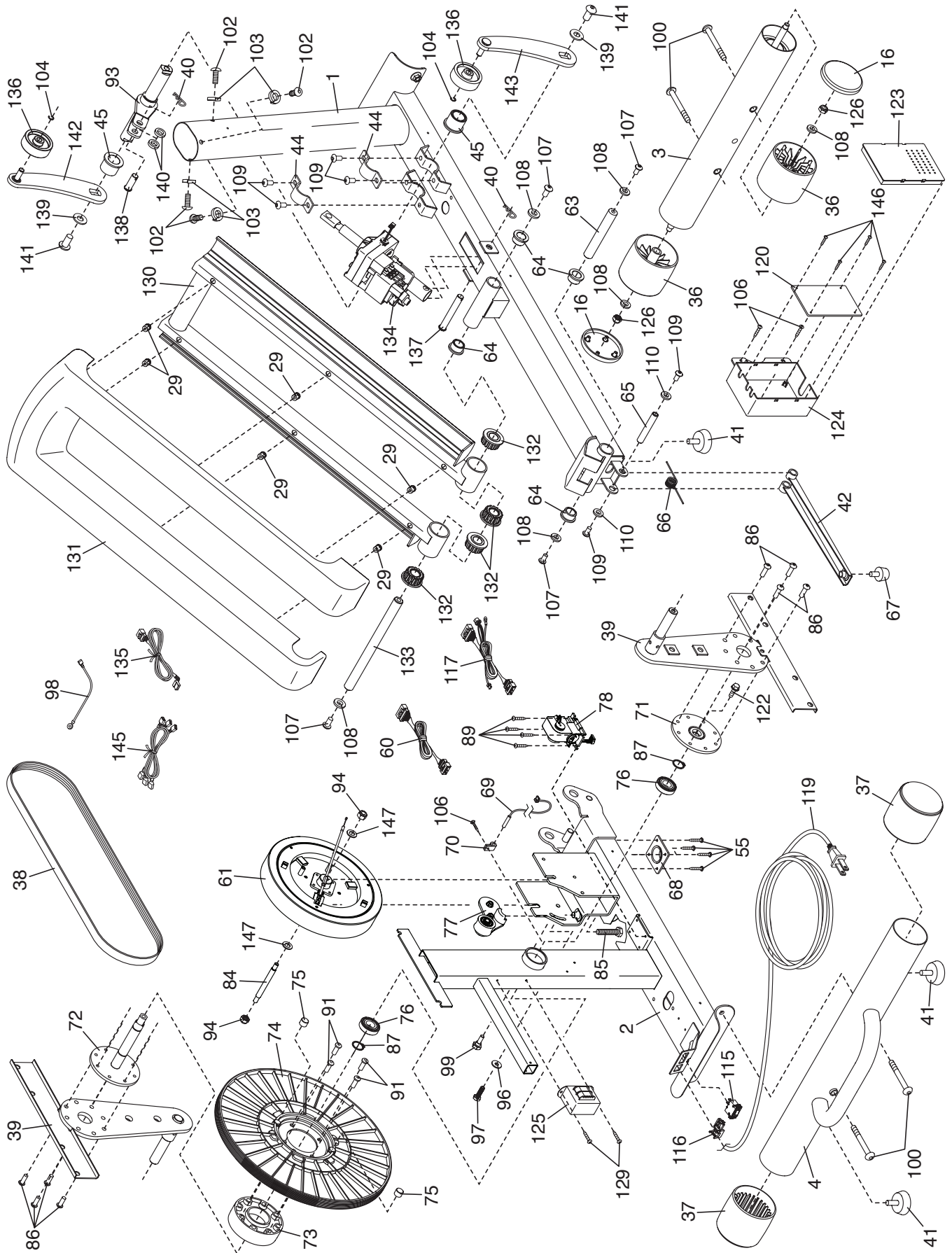

EXPLODED DRAWING C

Model No. PFEL18010.7 R1213A

