

EXPLODED DRAWING A

Model No. PFEL18012.2 R0214A

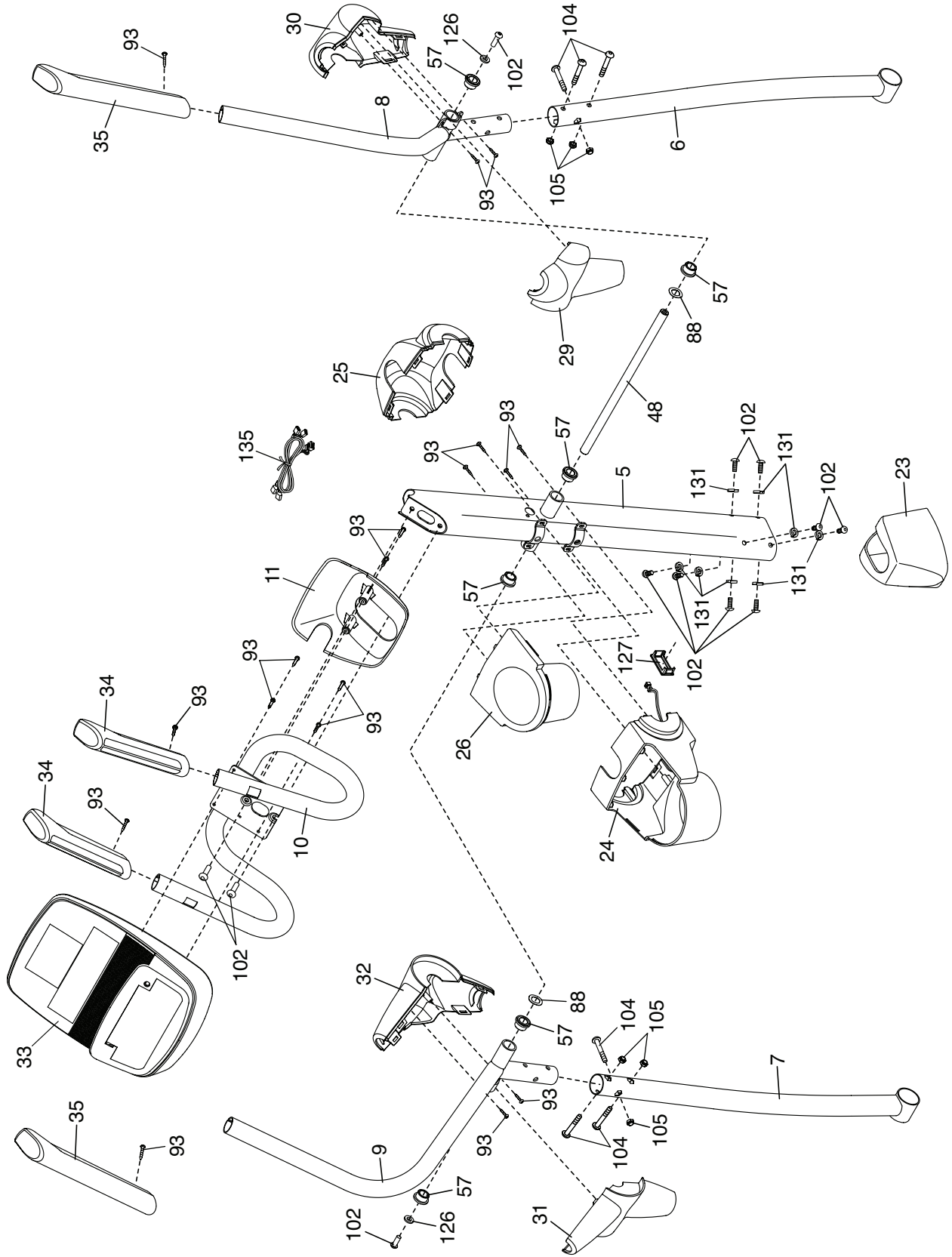

EXPLODED DRAWING B

Model No. PFEL18012.2 R0214A

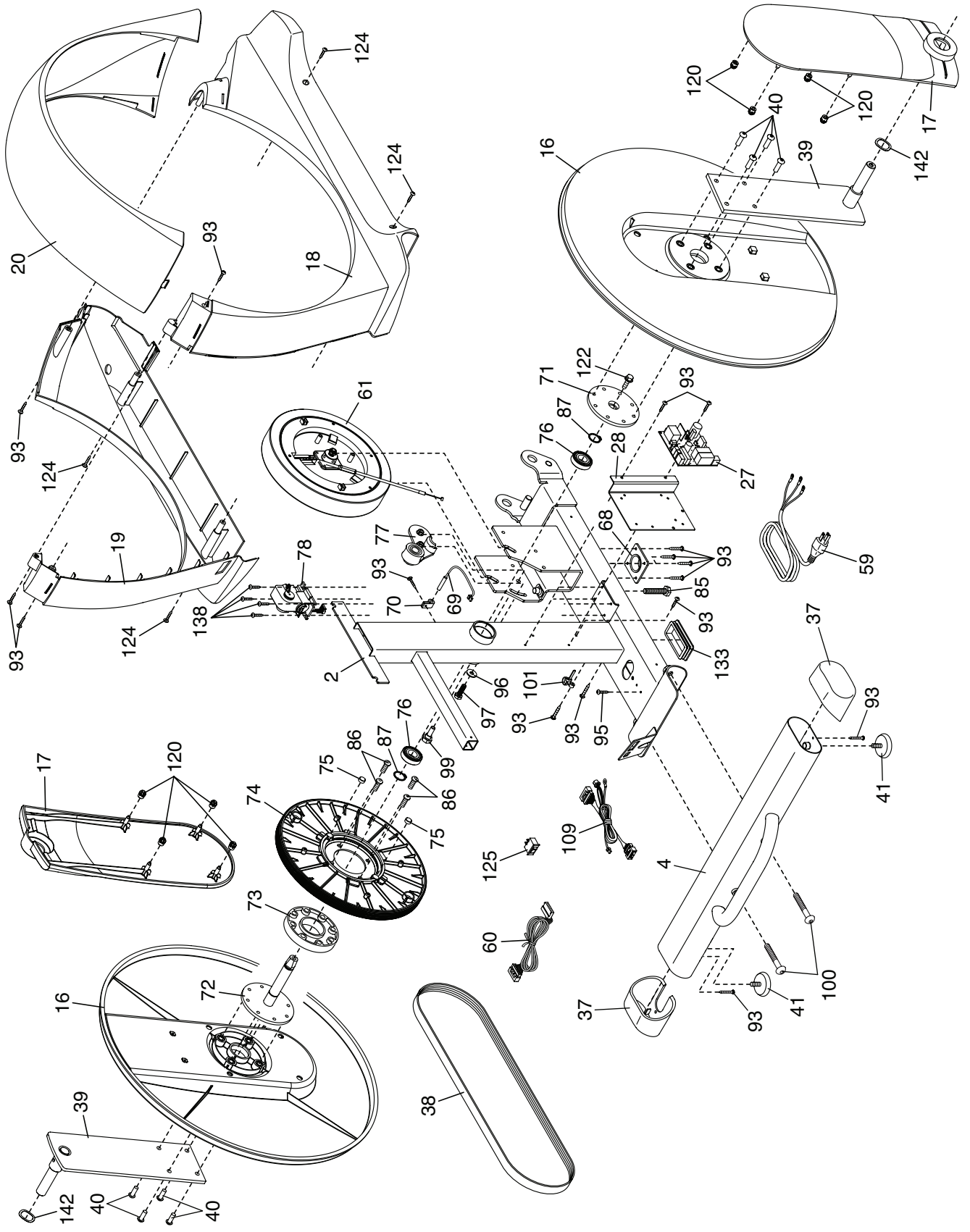

EXPLODED DRAWING C

Model No. PFEL18012.2 R0214A

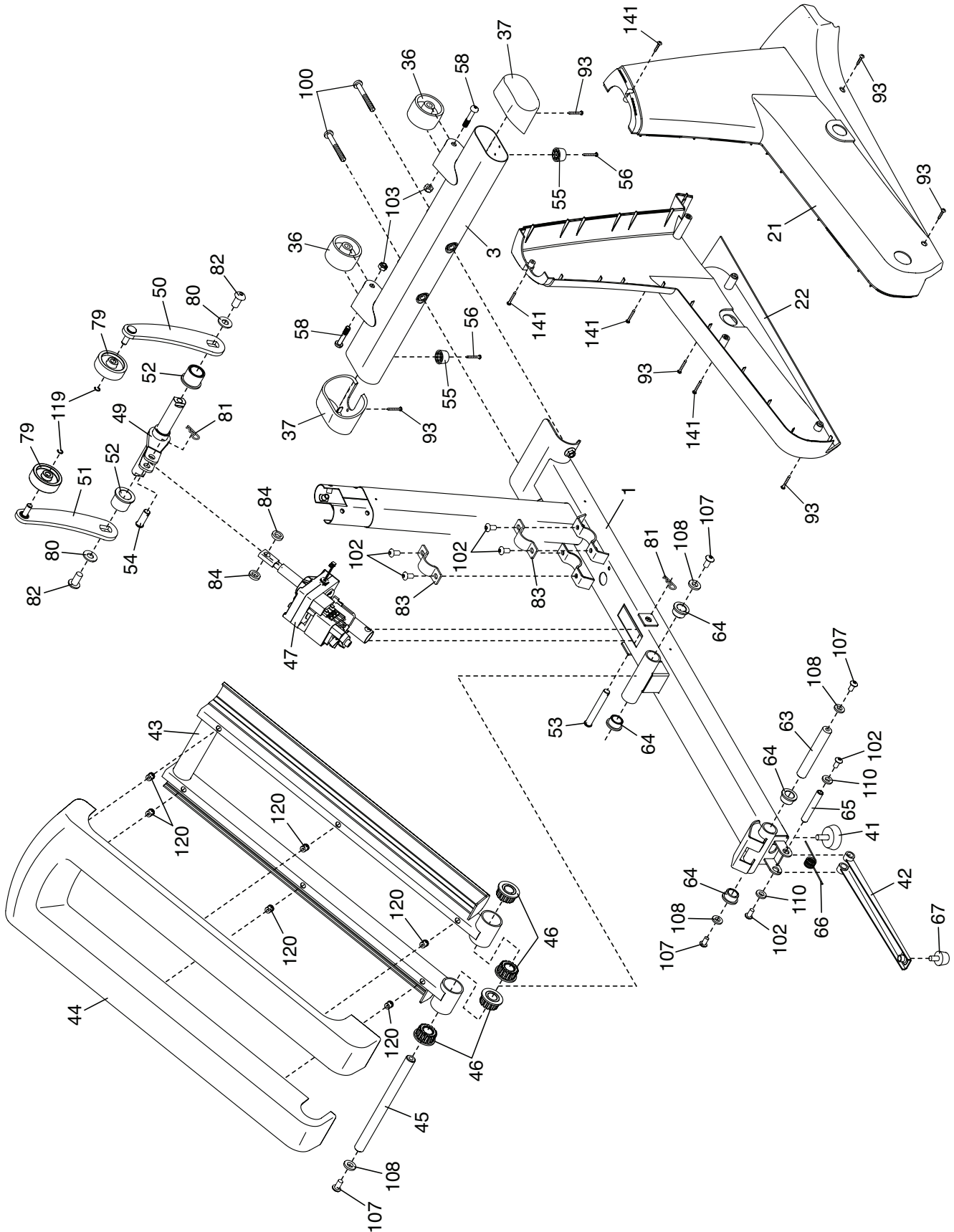

EXPLODED DRAWING D

Model No. PFEL18012.2 R0214A

