

# EXPLODED DRAWING A

Model No. PFEL18014.1 R1215A

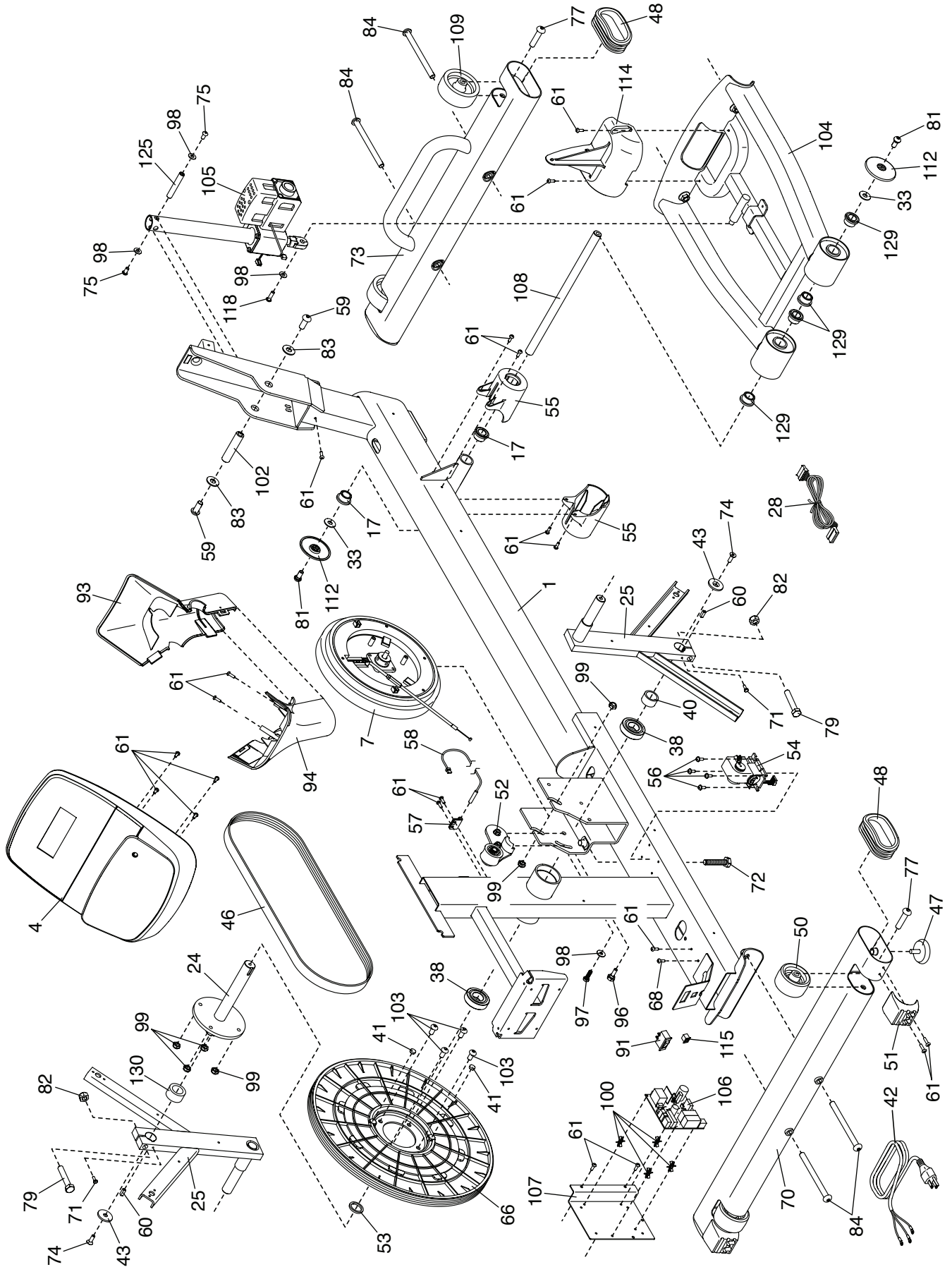

# EXPLODED DRAWING B

Model No. PFEL18014.1 R1215A

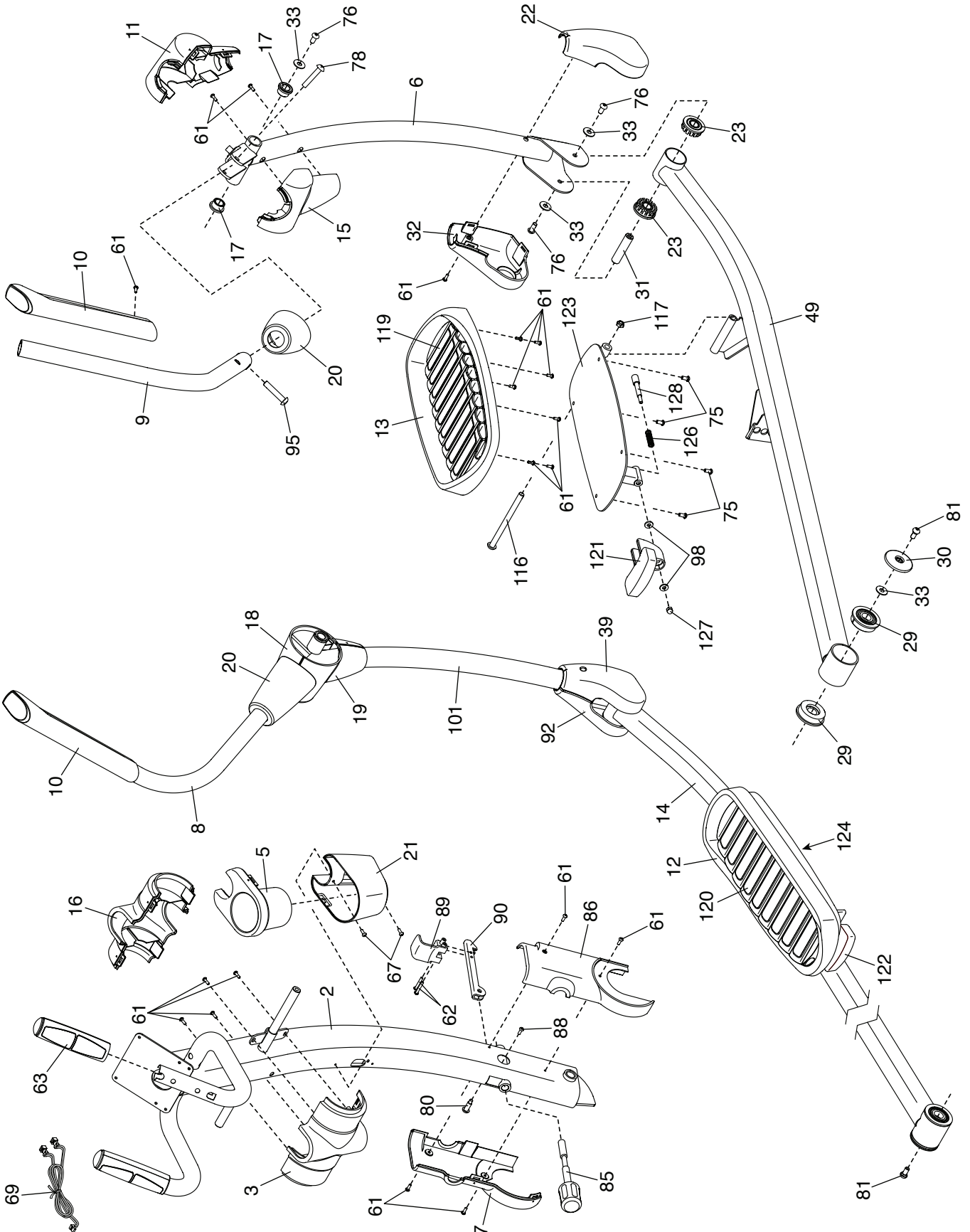

# EXPLODED DRAWING C

Model No. PFEL18014.1 R1215A

