

EXPLODED DRAWING A

Model No. PFEL19914.2 R0116A

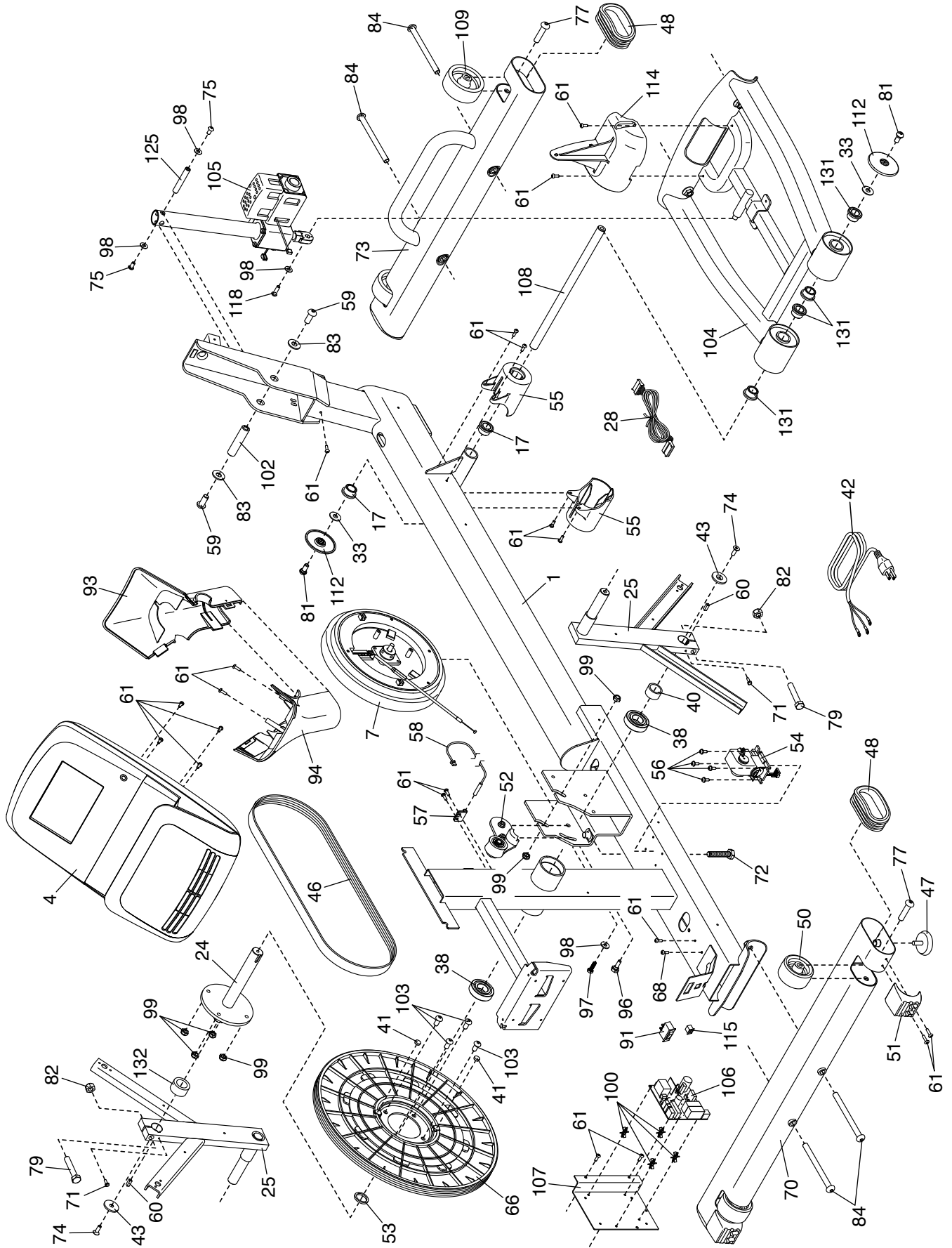

EXPLODED DRAWING B

Model No. PFEL19914.2 R0116A

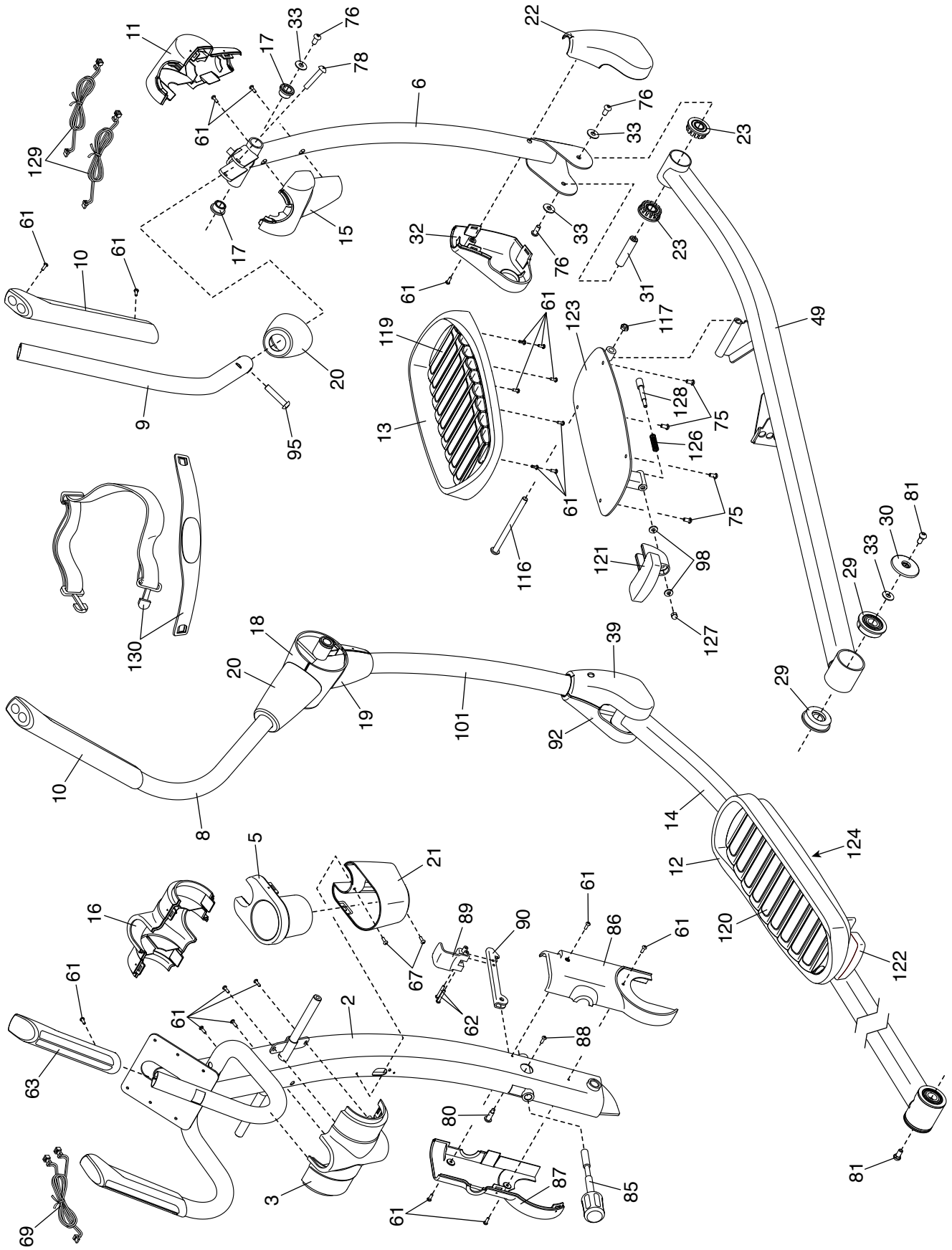

EXPLODED DRAWING C

Model No. PFEL19914.2 R0116A

