

# EXPLODED DRAWING A

Model No. PFEL19914.0 R0514A

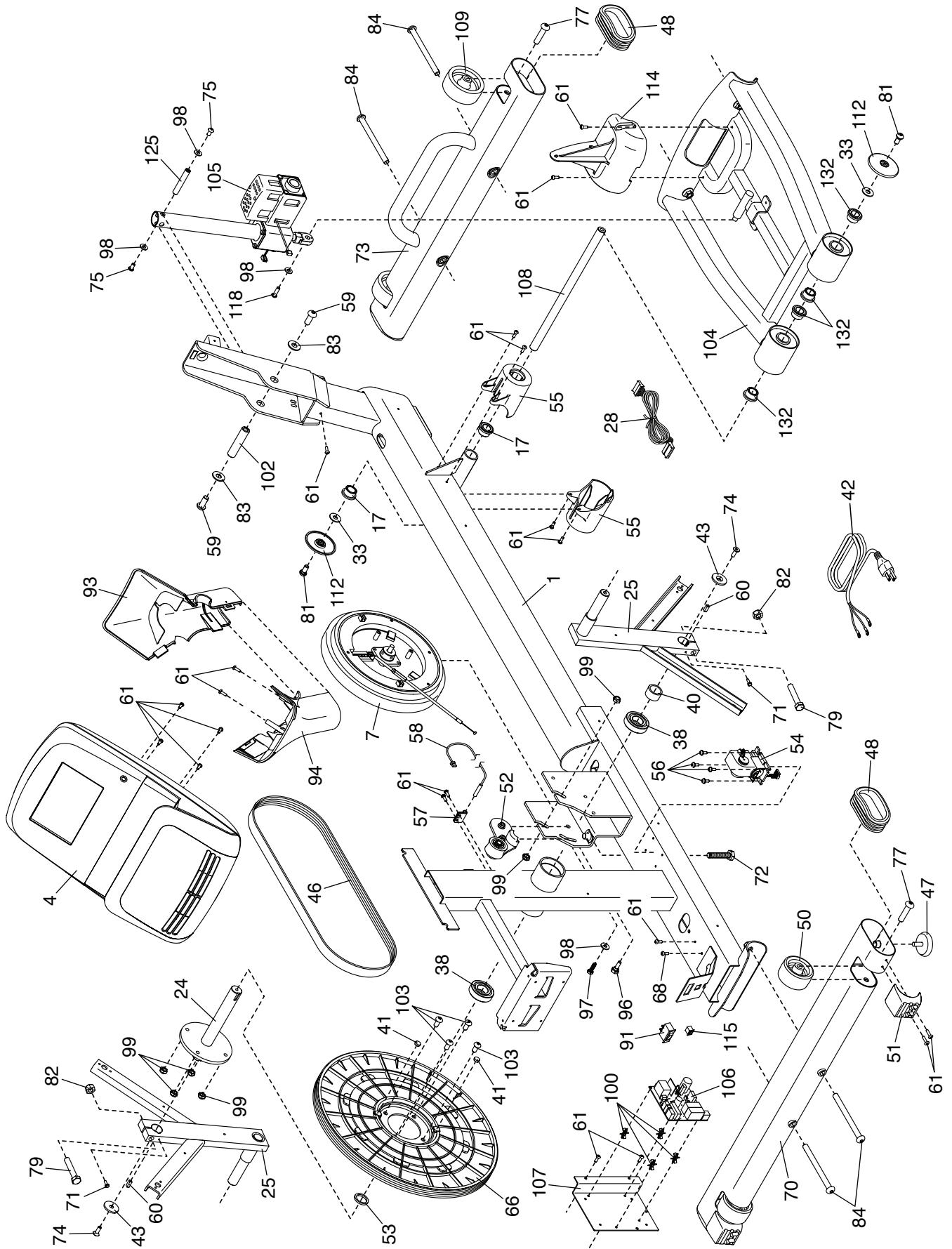

# EXPLODED DRAWING B

Model No. PFEL19914.0 R0514A

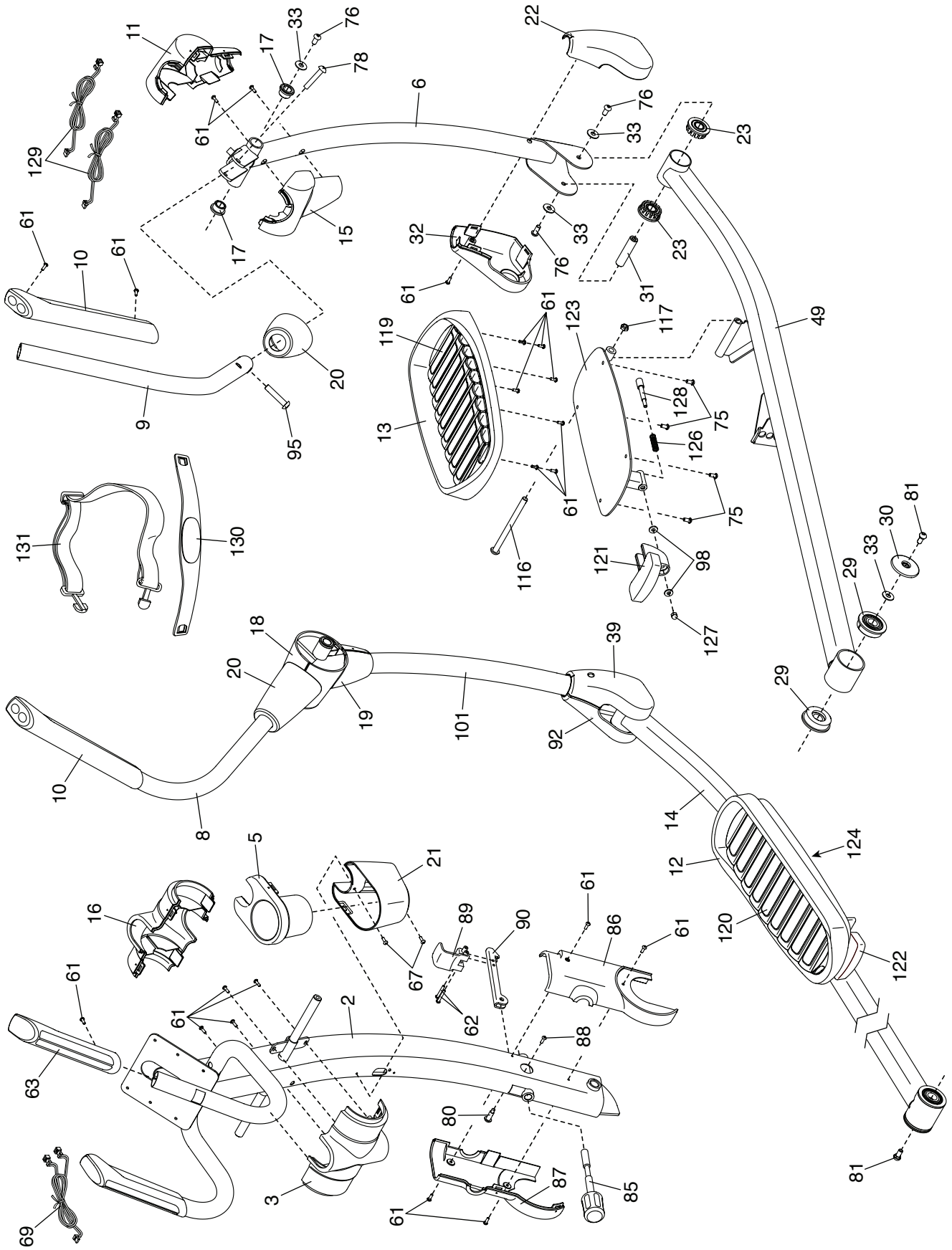

# EXPLODED DRAWING C

Model No. PFEL19914.0 R0514A

