

EXPLODED DRAWING A

Model No. PFEL19914.1 R0814A

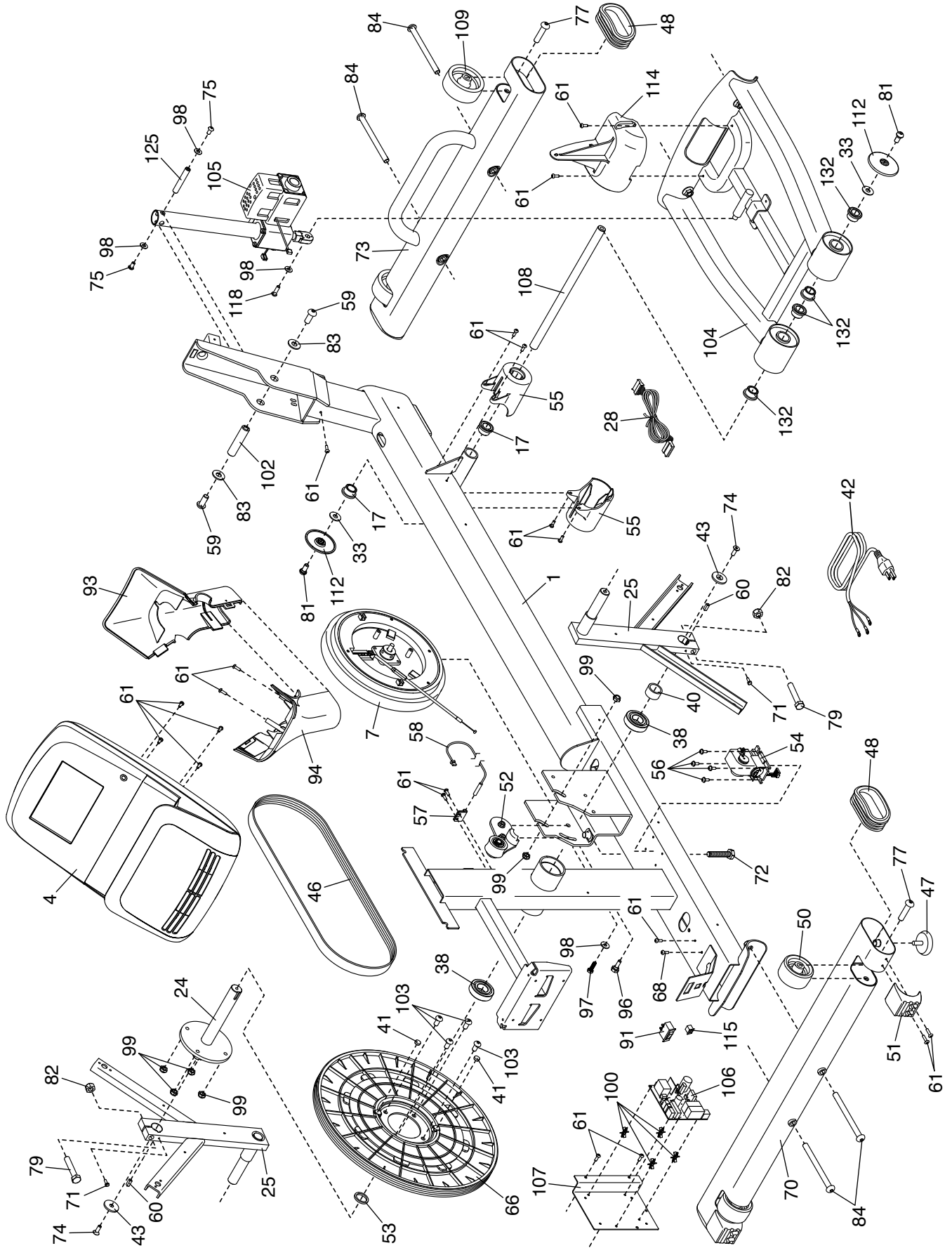

EXPLODED DRAWING B

Model No. PFEL19914.1 R0814A

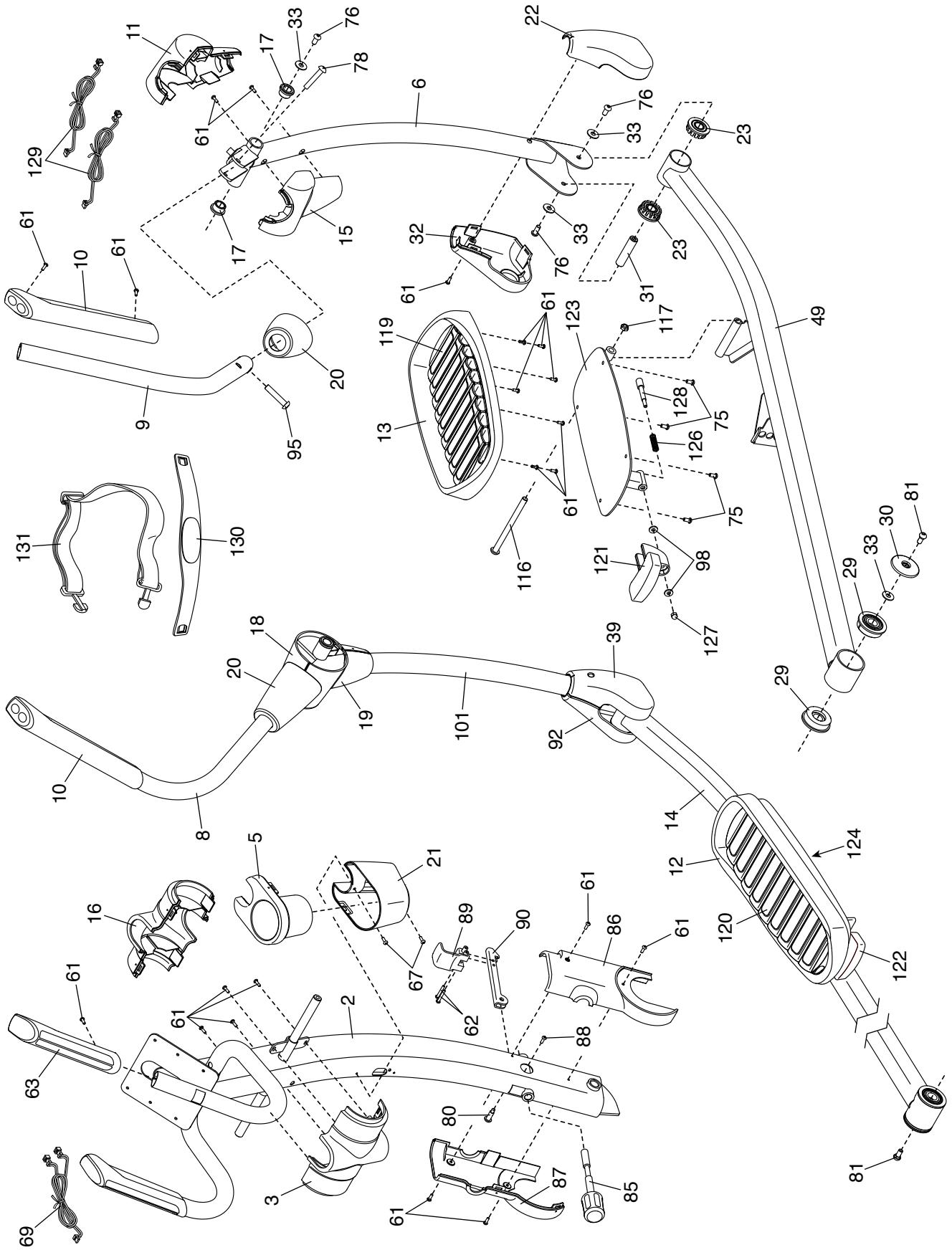

EXPLODED DRAWING C

Model No. PFEL19914.1 R0814A

