

# EXPLODED DRAWING A

Model No. PFEL21214.0 R1214A

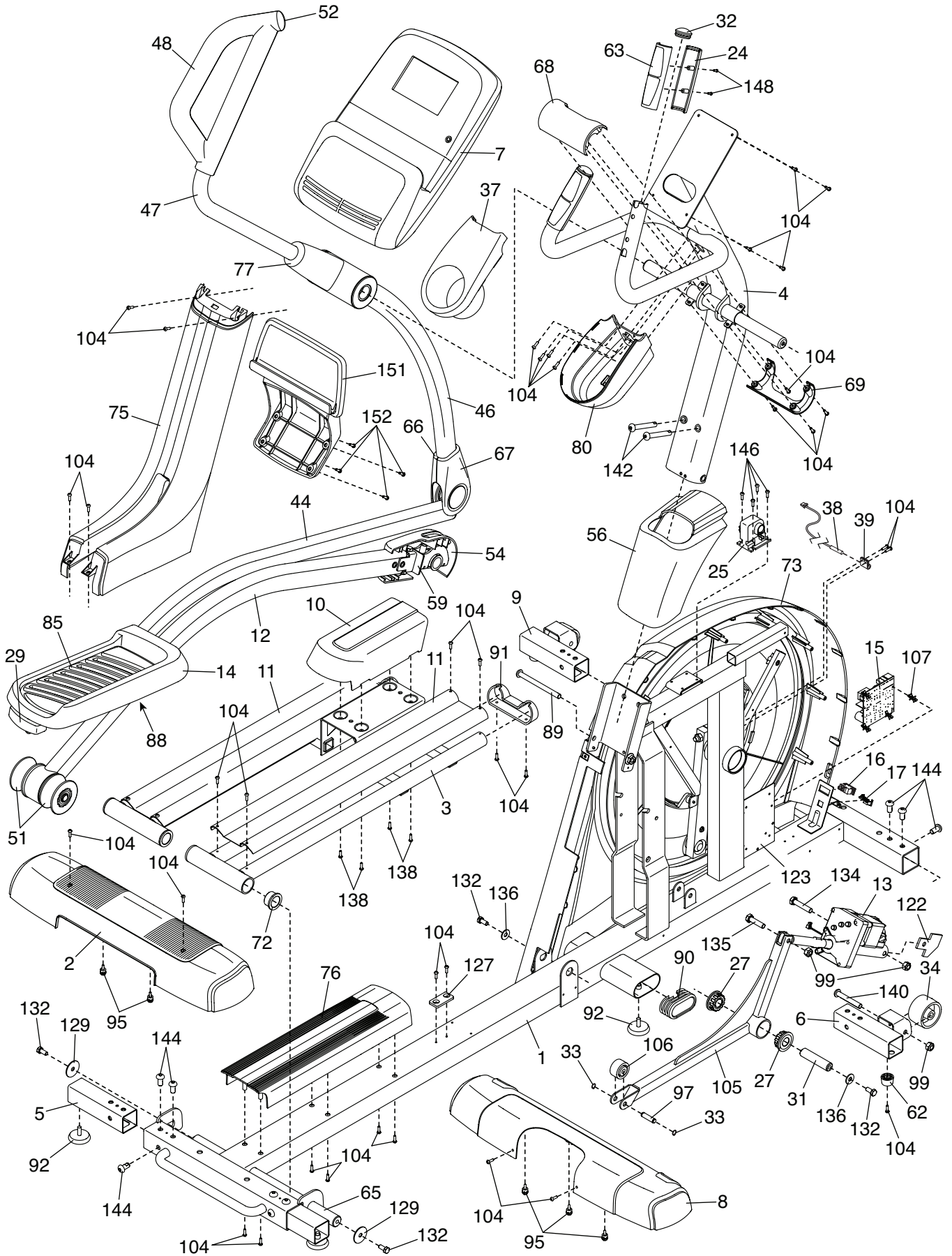

# EXPLODED DRAWING B

Model No. PFEL21214.0 R1214A

