

EXPLODED DRAWING A

Model No. PFEL21214.1 R0615A

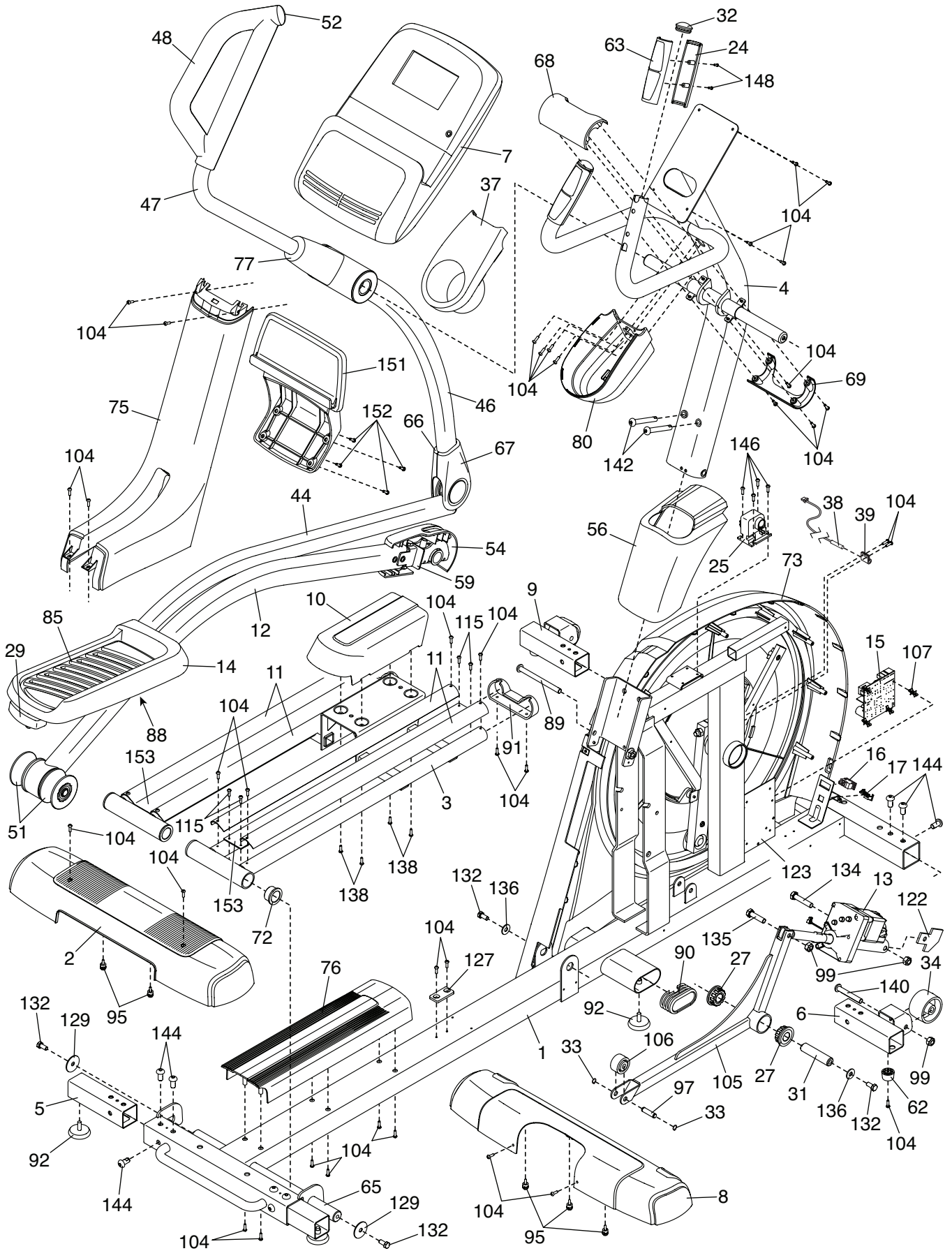

EXPLODED DRAWING B

Model No. PFEL21214.1 R0615A

