

# EXPLODED DRAWING A

Model No. PFEL21614.1 R0815A

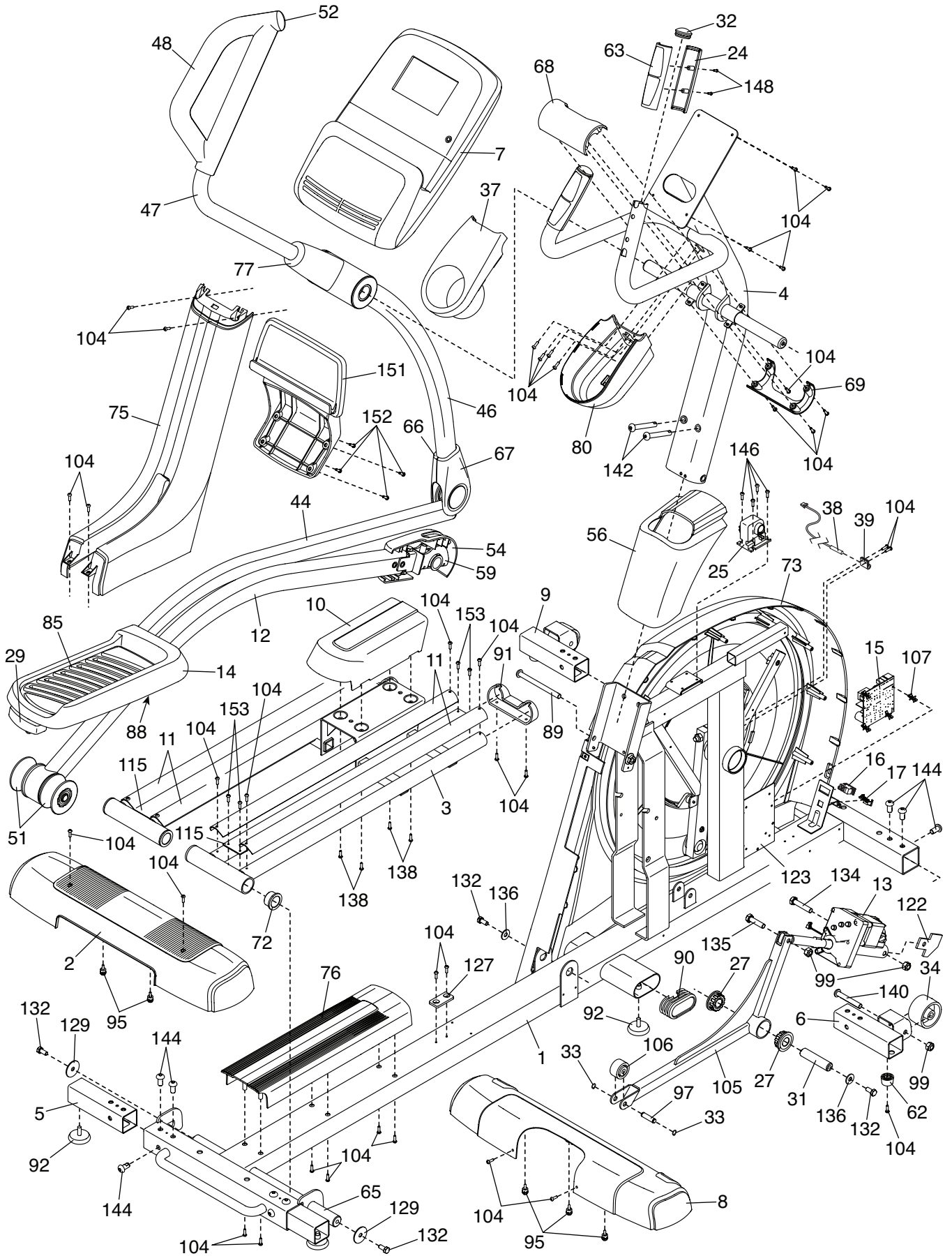

# EXPLODED DRAWING B

Model No. PFEL21614.1 R0815A

