

EXPLODED DRAWING A

Model No. PFEL31016.1 R0118A

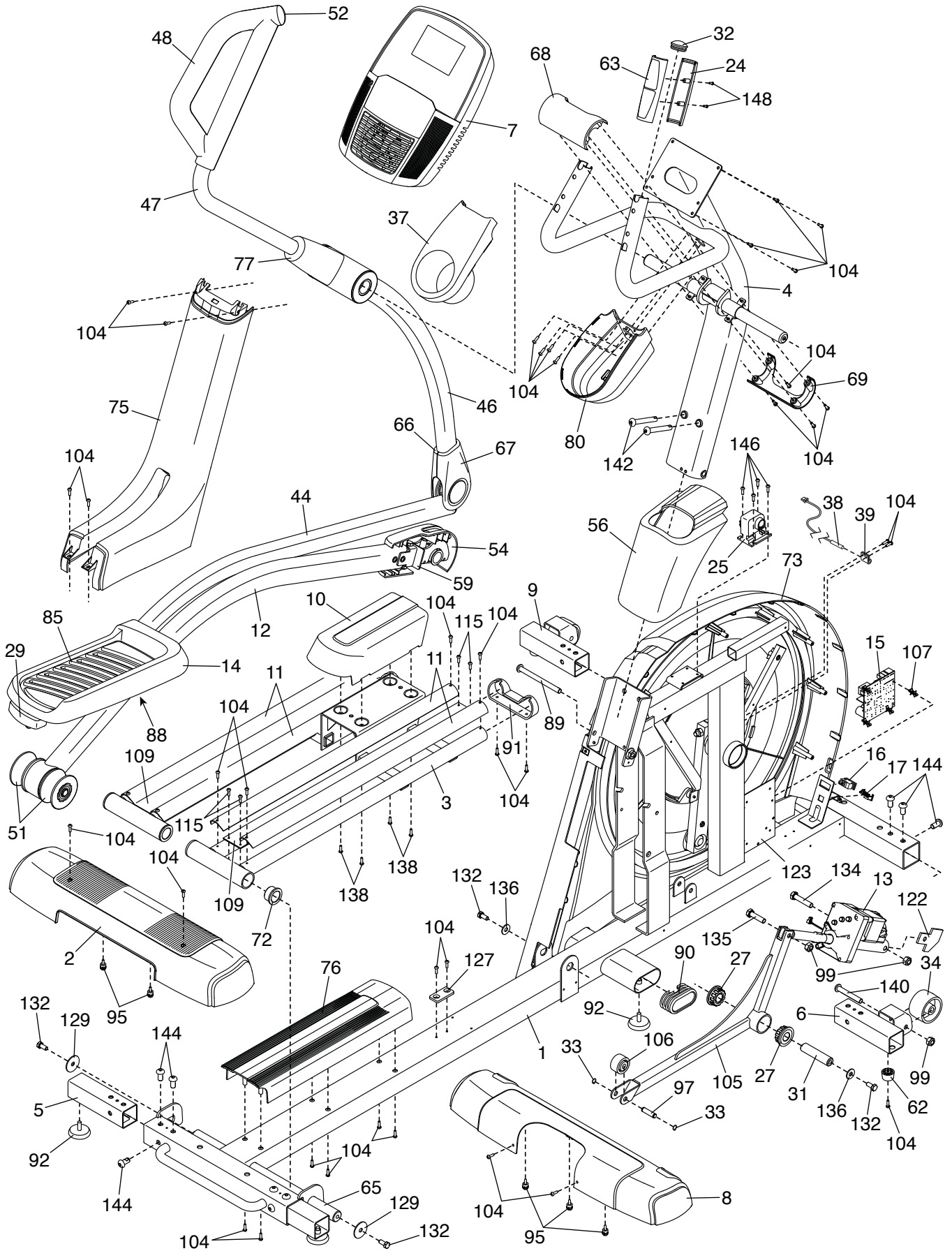

EXPLODED DRAWING B

Model No. PFEL31016.1 R0118A

