

# EXPLODED DRAWING A

Model No. PFEL31115.0 R1215A

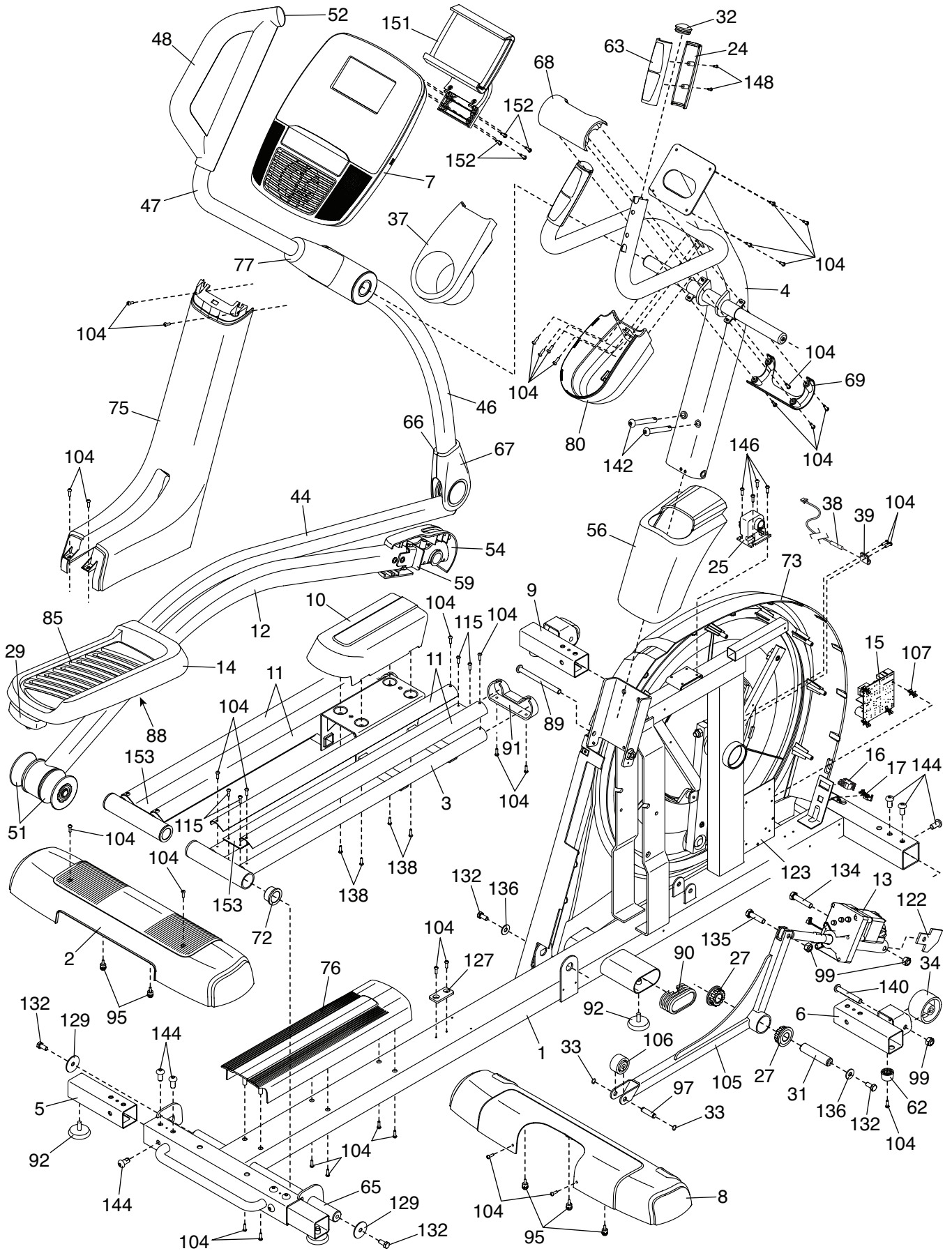

# EXPLODED DRAWING B

Model No. PFEL31115.0 R1215A

