

EXPLODED DRAWING A

Model No. PFEL31115.1 R1217A

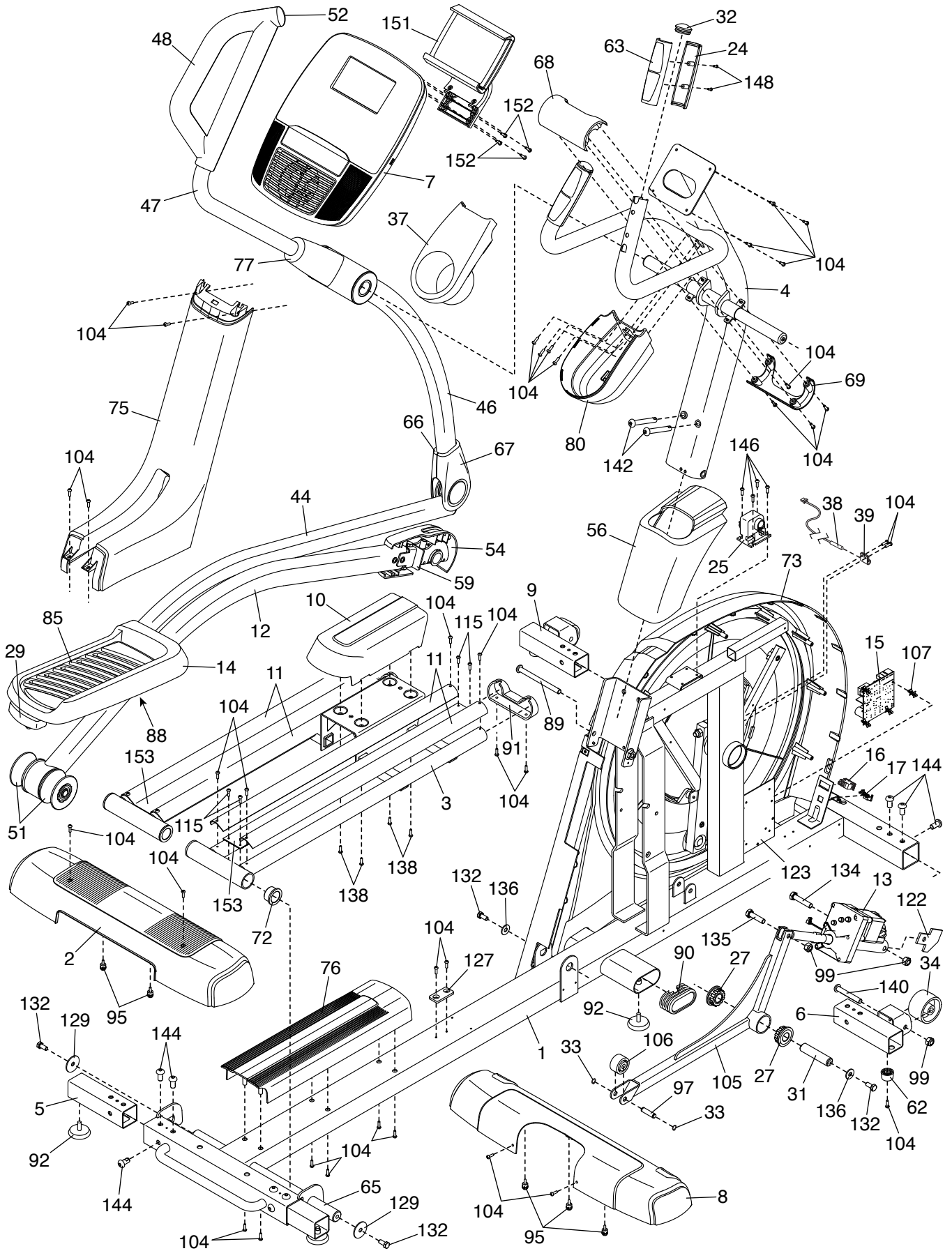

EXPLODED DRAWING B

Model No. PFEL31115.1 R1217A

