

EXPLODED DRAWING A

Model No. PFEL31315.3 R0718A

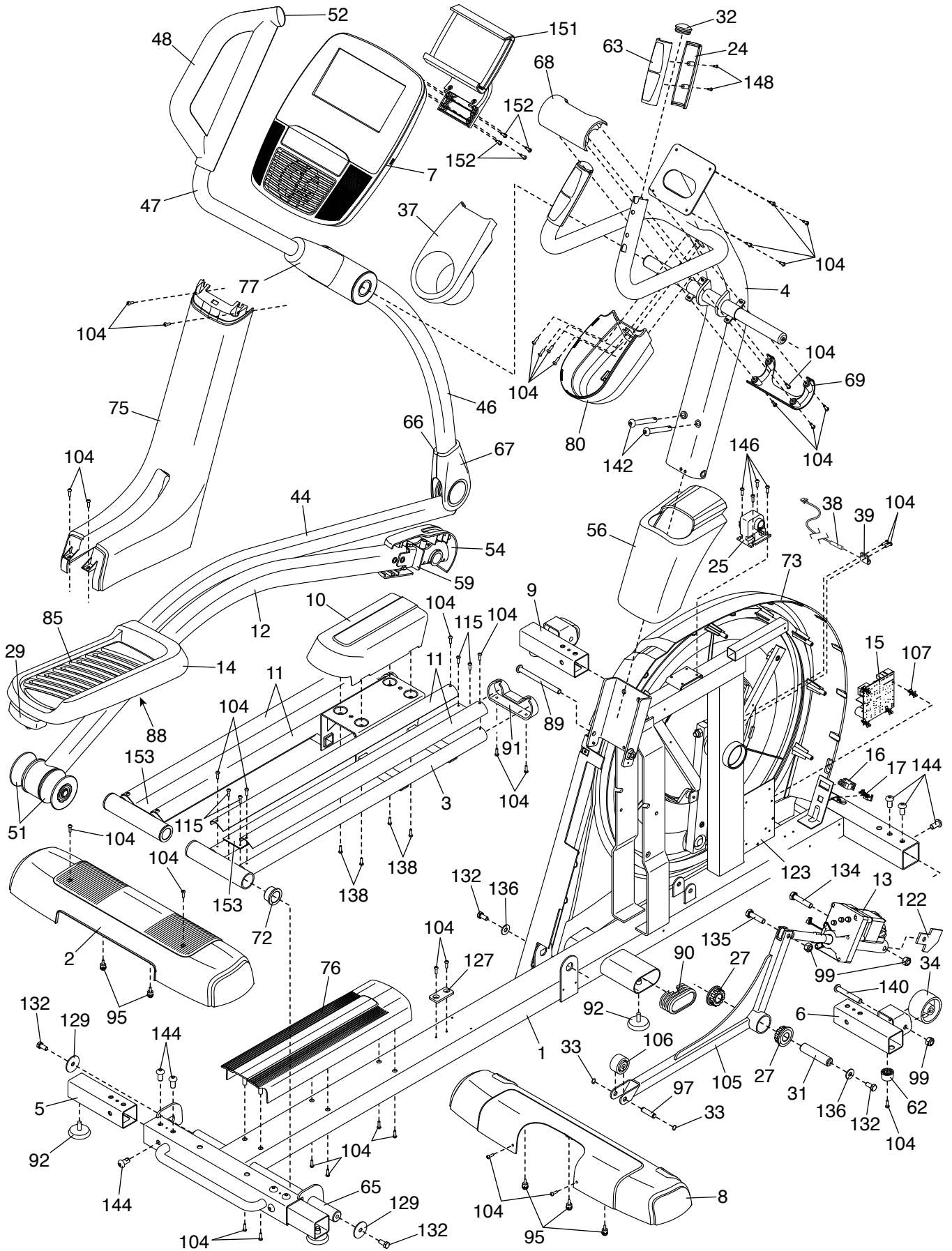

EXPLODED DRAWING B

Model No. PFEL31315.3 R0718A

