

EXPLODED DRAWING A

Model No. PFEL31315.1 R0616A

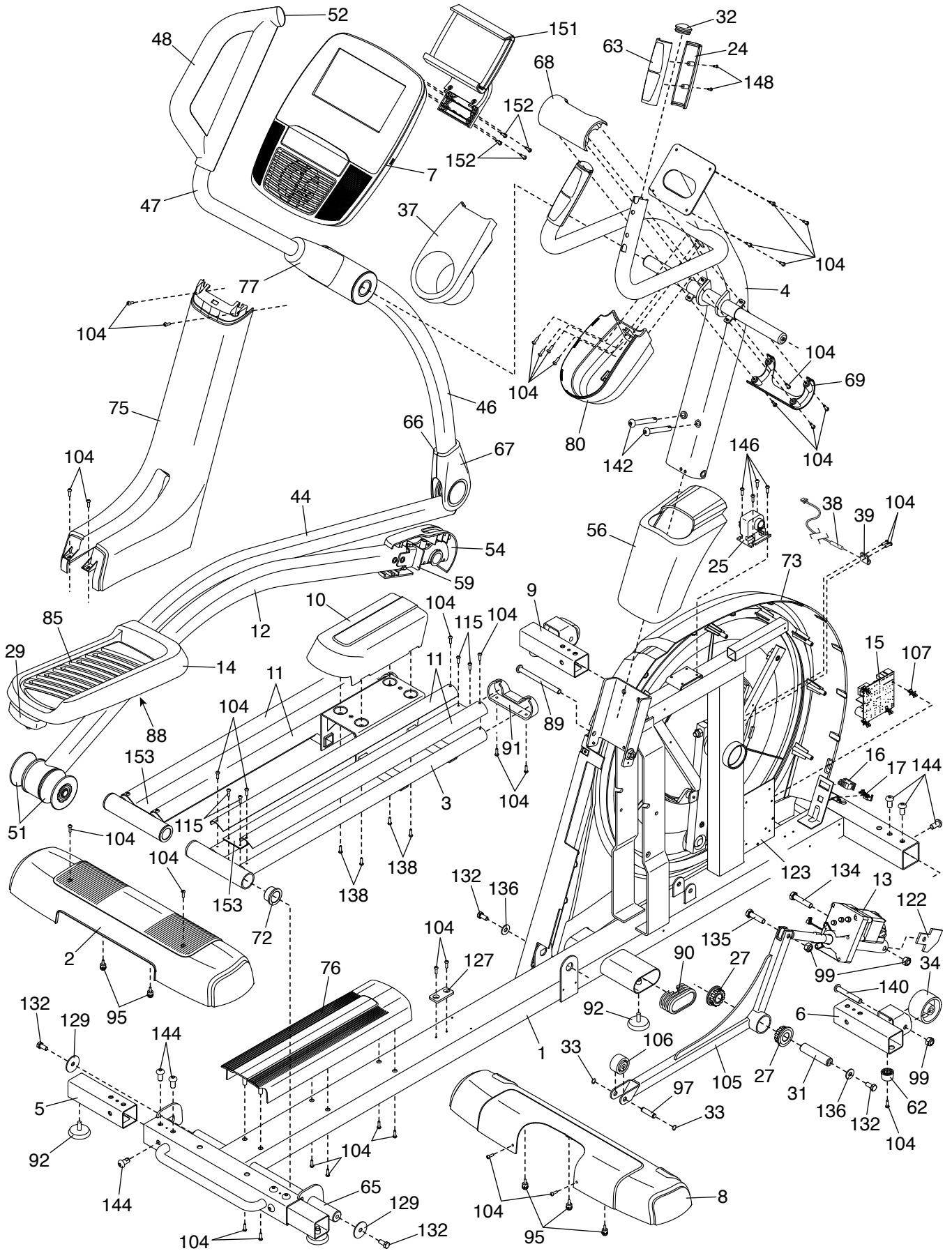

EXPLODED DRAWING B

Model No. PFEL31315.1 R0616A

