

EXPLODED DRAWING A—Model No. PFEL5055.0

R0506A

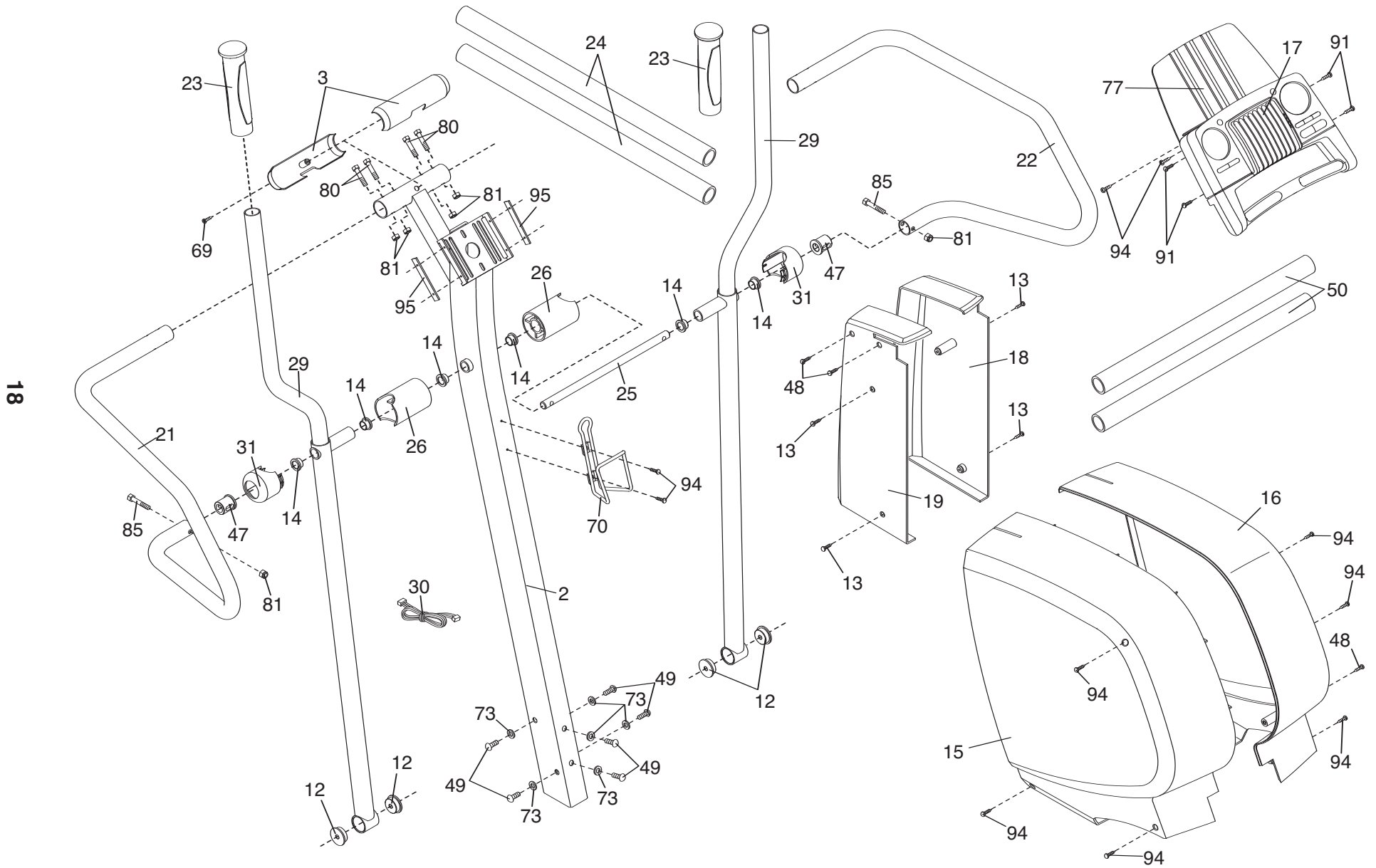

EXPLODED DRAWING B—Model No. PFEL5055.0

R0506A

19

