

EXPLODED DRAWING A

Model No. PFEL51517.0 R1117A

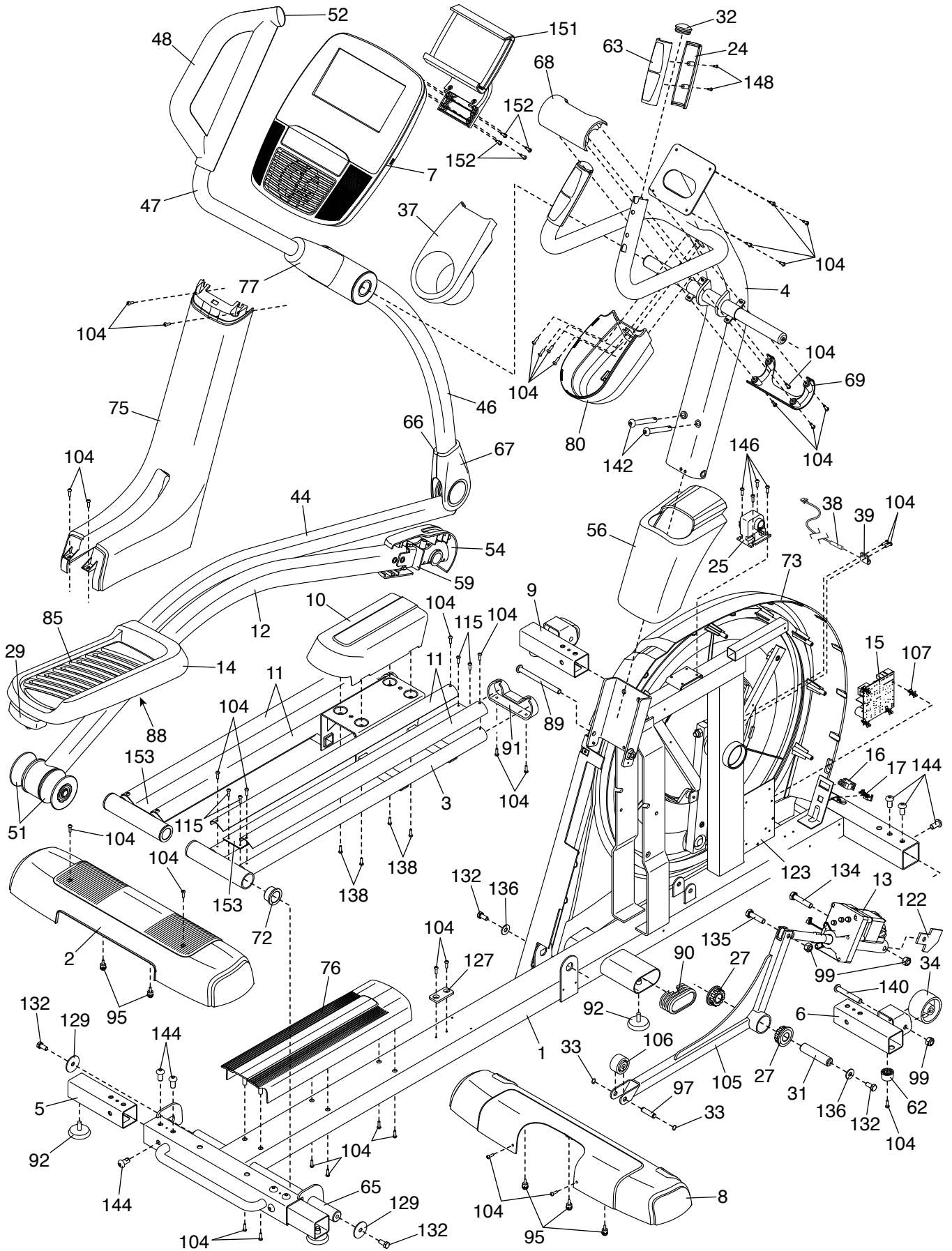

EXPLODED DRAWING B

Model No. PFEL51517.0 R1117A

