

EXPLODED DRAWING A

Model No. PFEL51517.1 R0518A

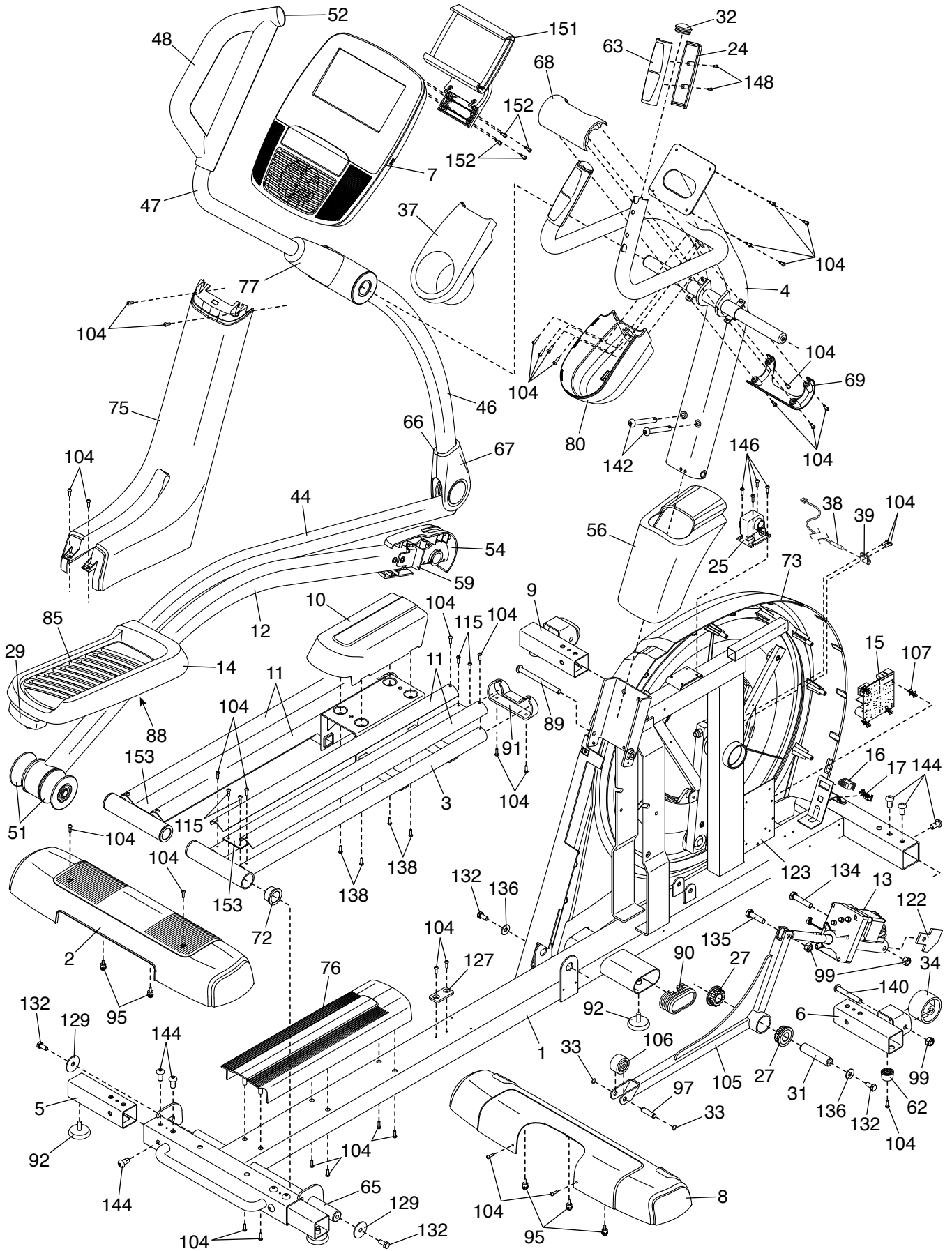

EXPLODED DRAWING B

Model No. PFEL51517.1 R0518A

