

# EXPLODED DRAWING A—Model No. PFEL53408.1

R0309A

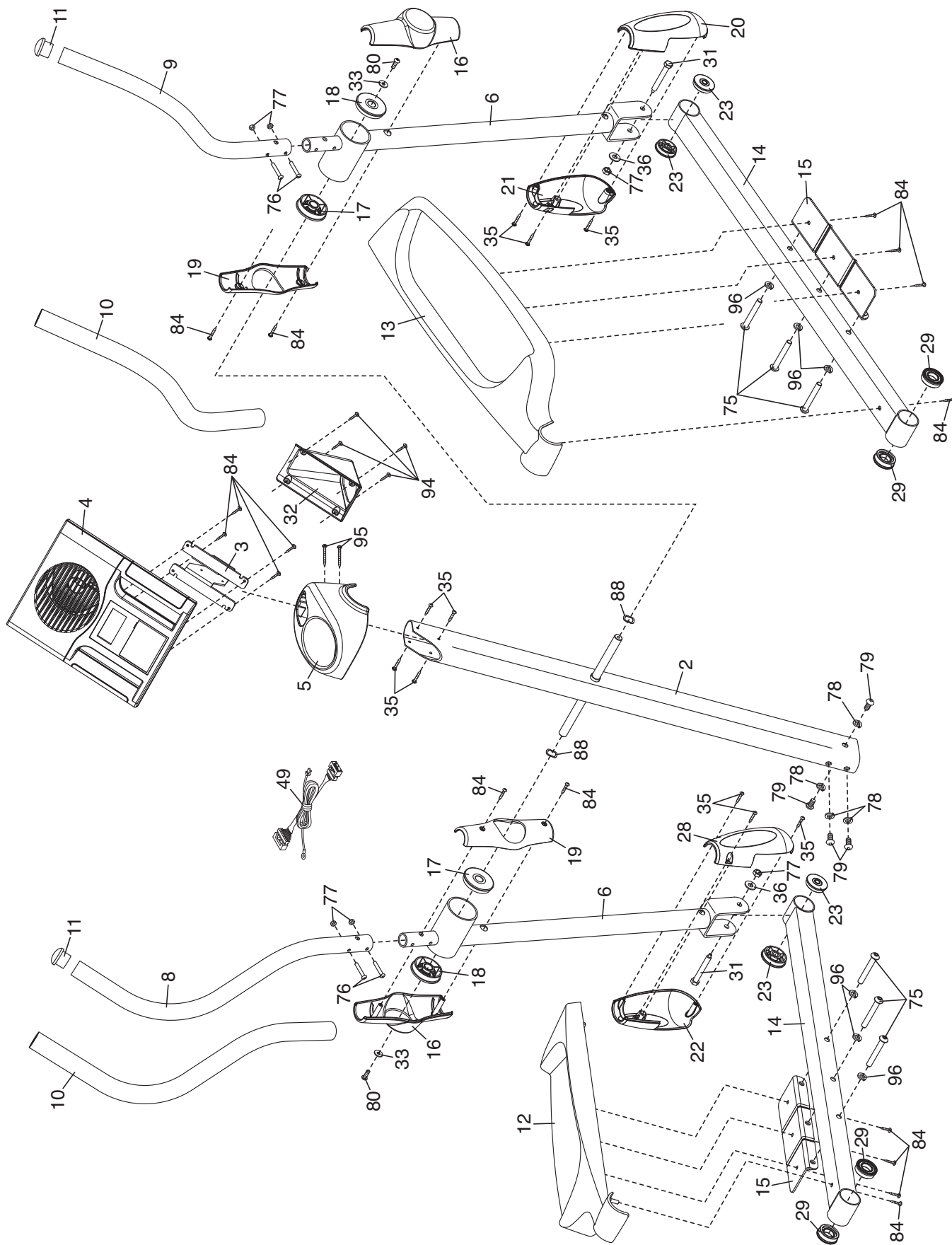

# EXPLODED DRAWING B—Model No. PFEL53408.1

R0309A

