

EXPLODED DRAWING A

Model No. PFEL53911.1 R0112A

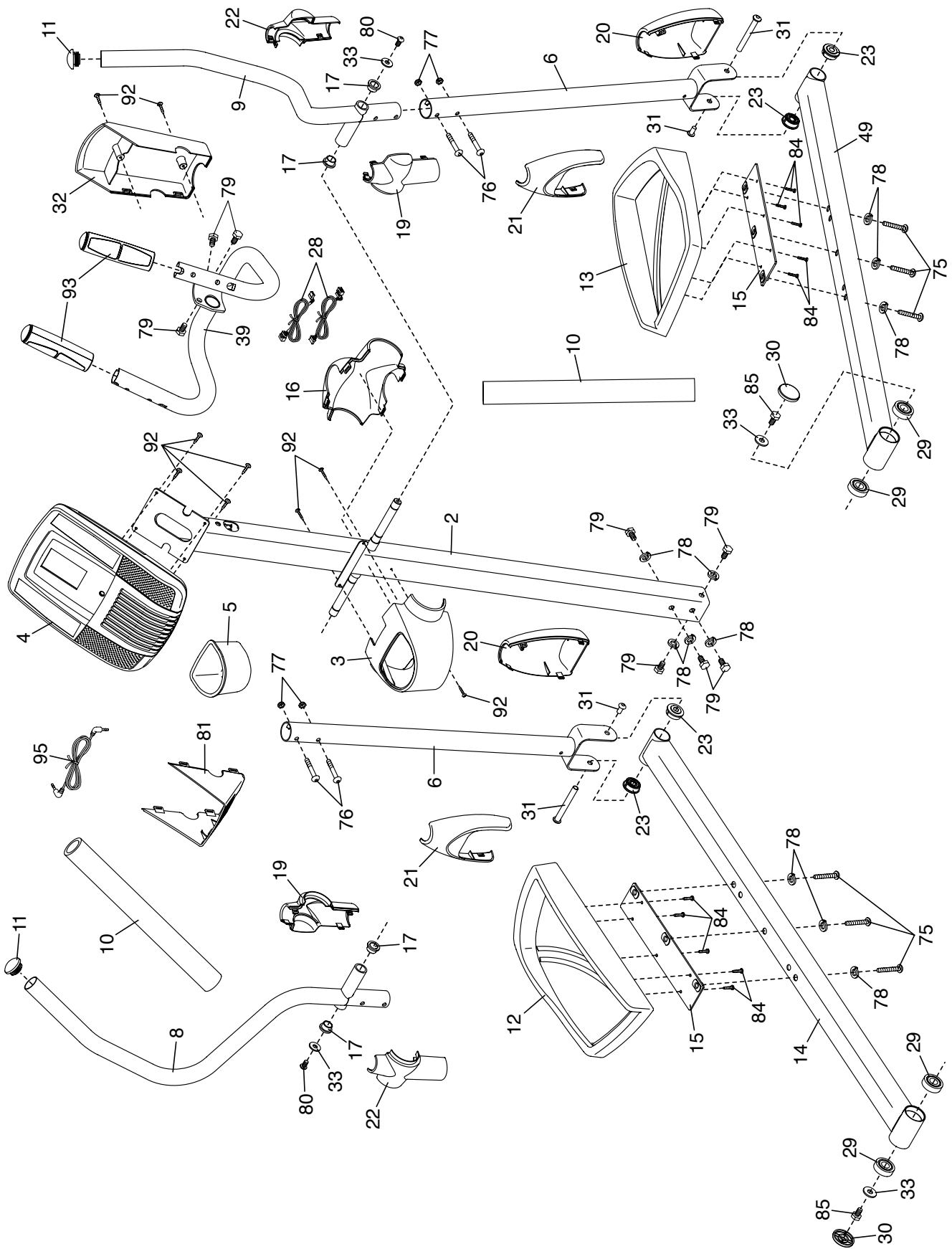

EXPLODED DRAWING B

Model No. PFEL53911.1 R0112A

