

# EXPLODED DRAWING A

Model No. PFEL53911.3 R1212A

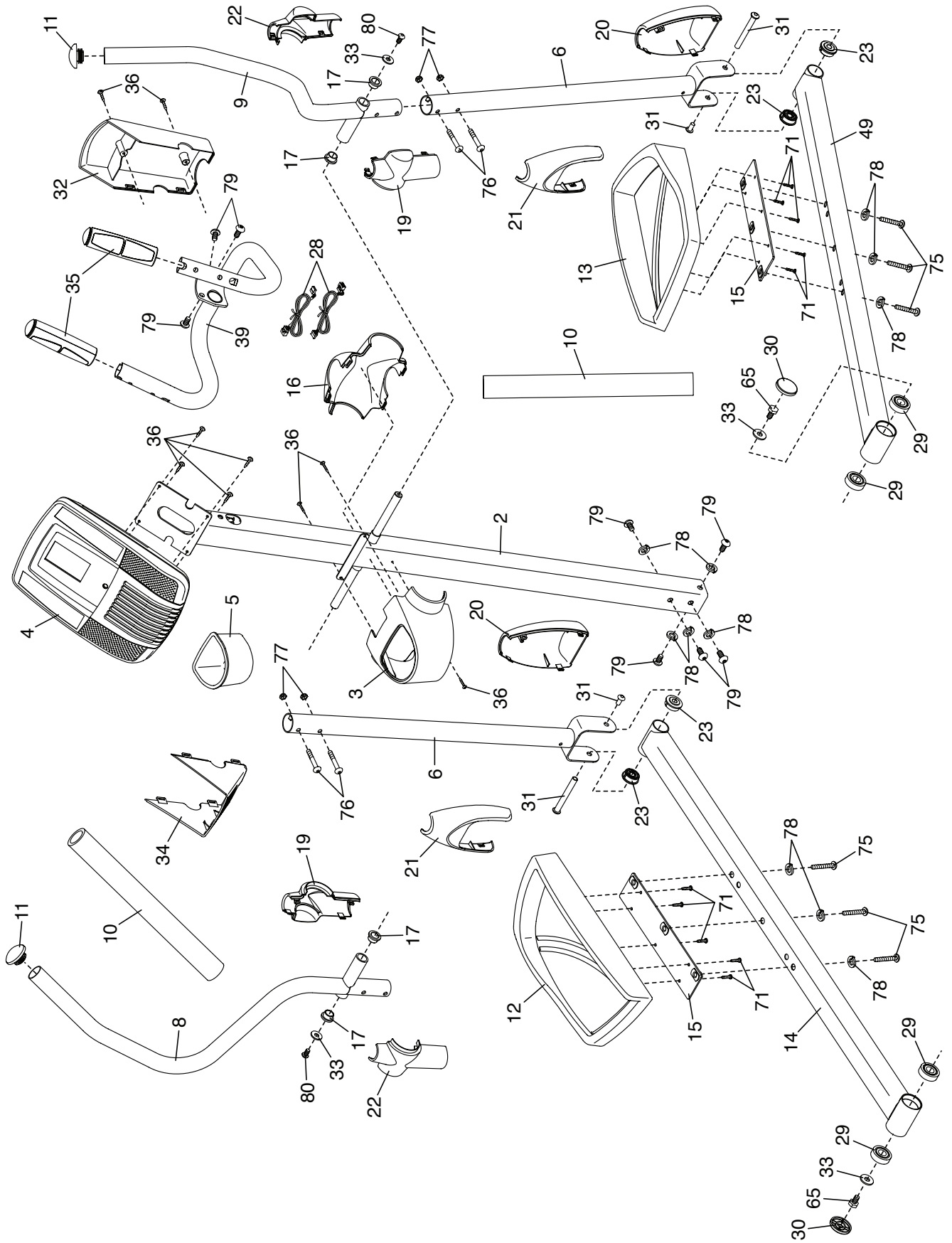

# EXPLODED DRAWING B

Model No. PFEL53911.3 R1212A

