

EXPLODED DRAWING A

Model No. PFEL53911.0 R1111A

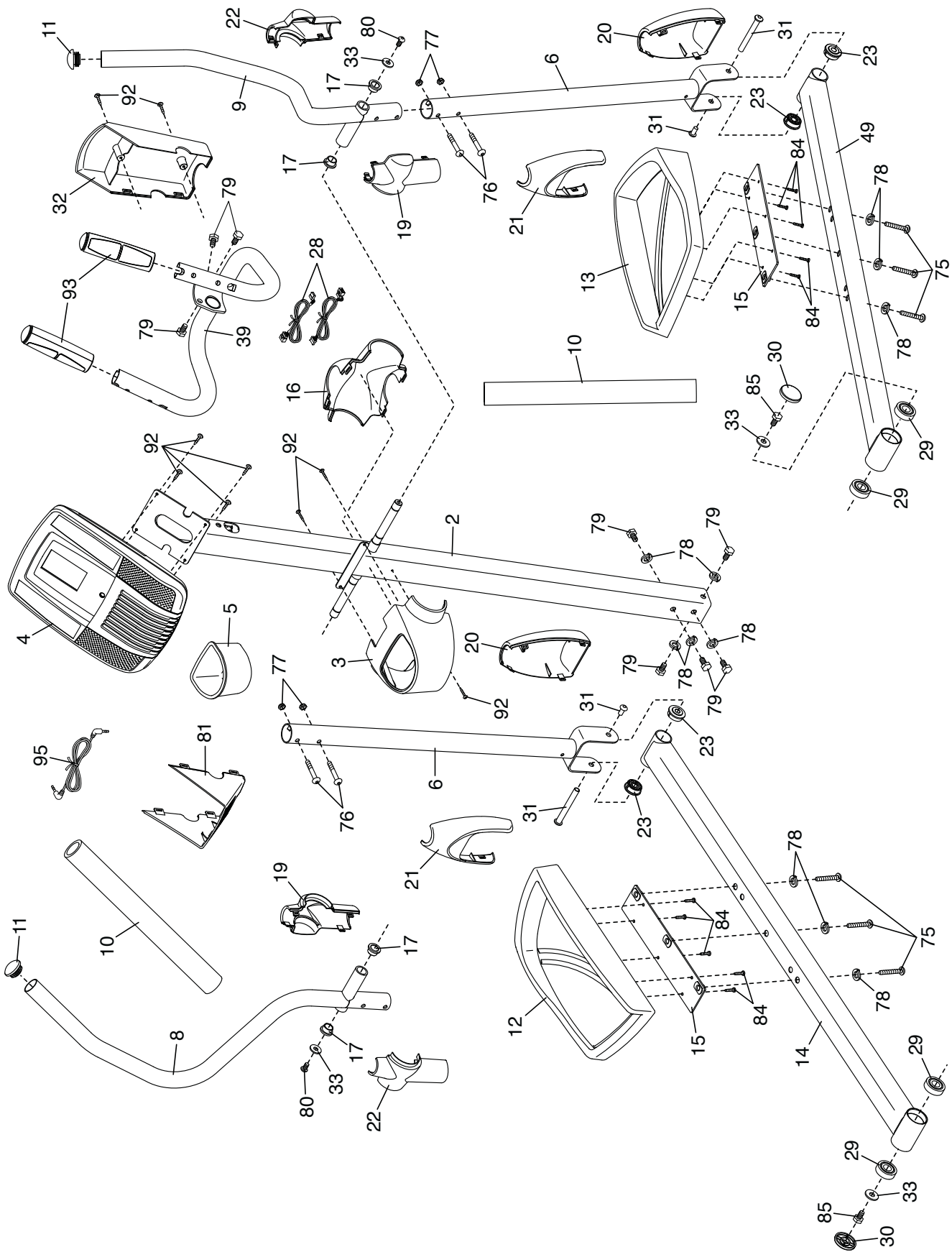

EXPLODED DRAWING B

Model No. PFEL53911.0 R1111A

