

EXPLODED DRAWING A

Model No. PFEL55911.6 R0113A

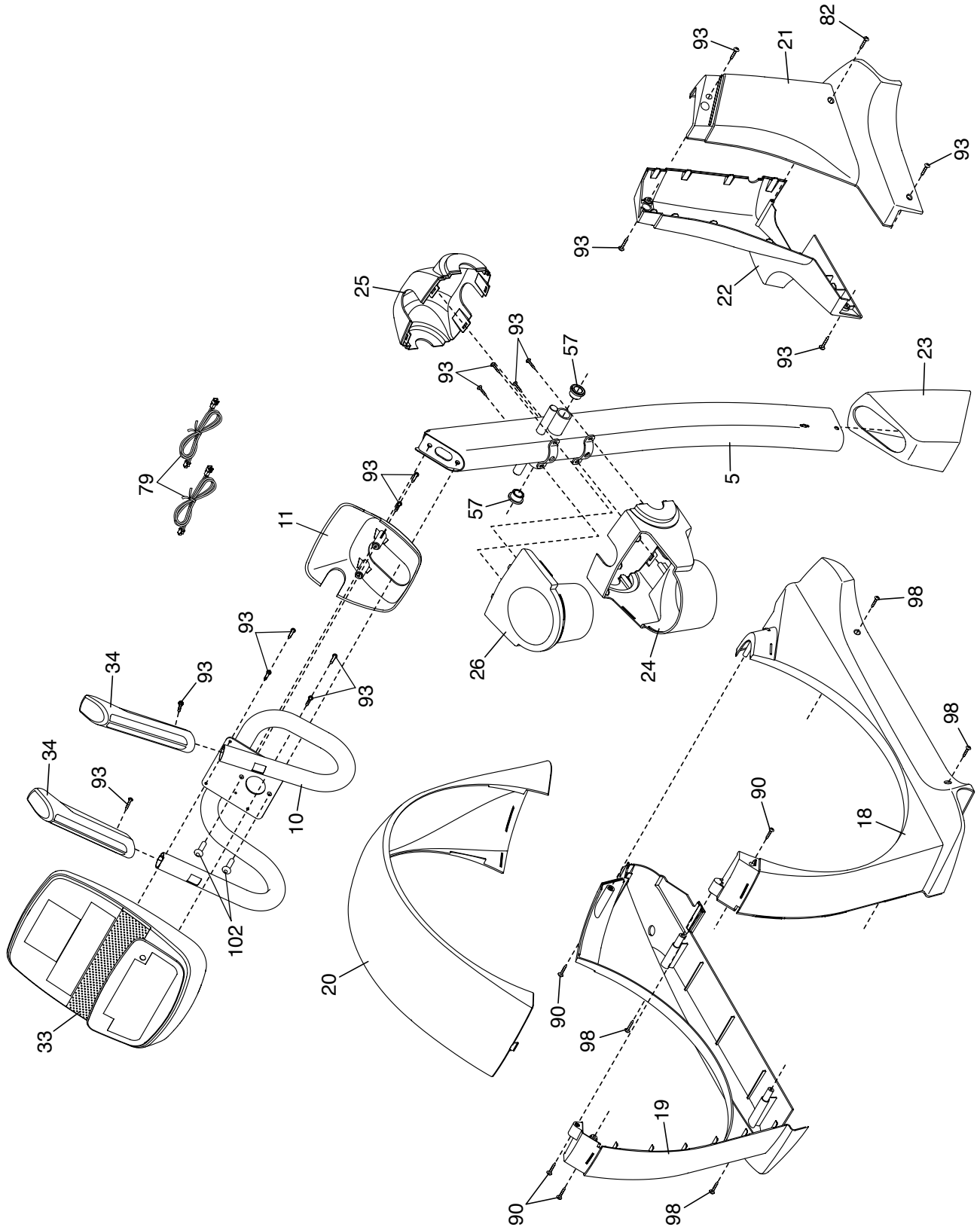

EXPLODED DRAWING B

Model No. PFEL55911.6 R0113A

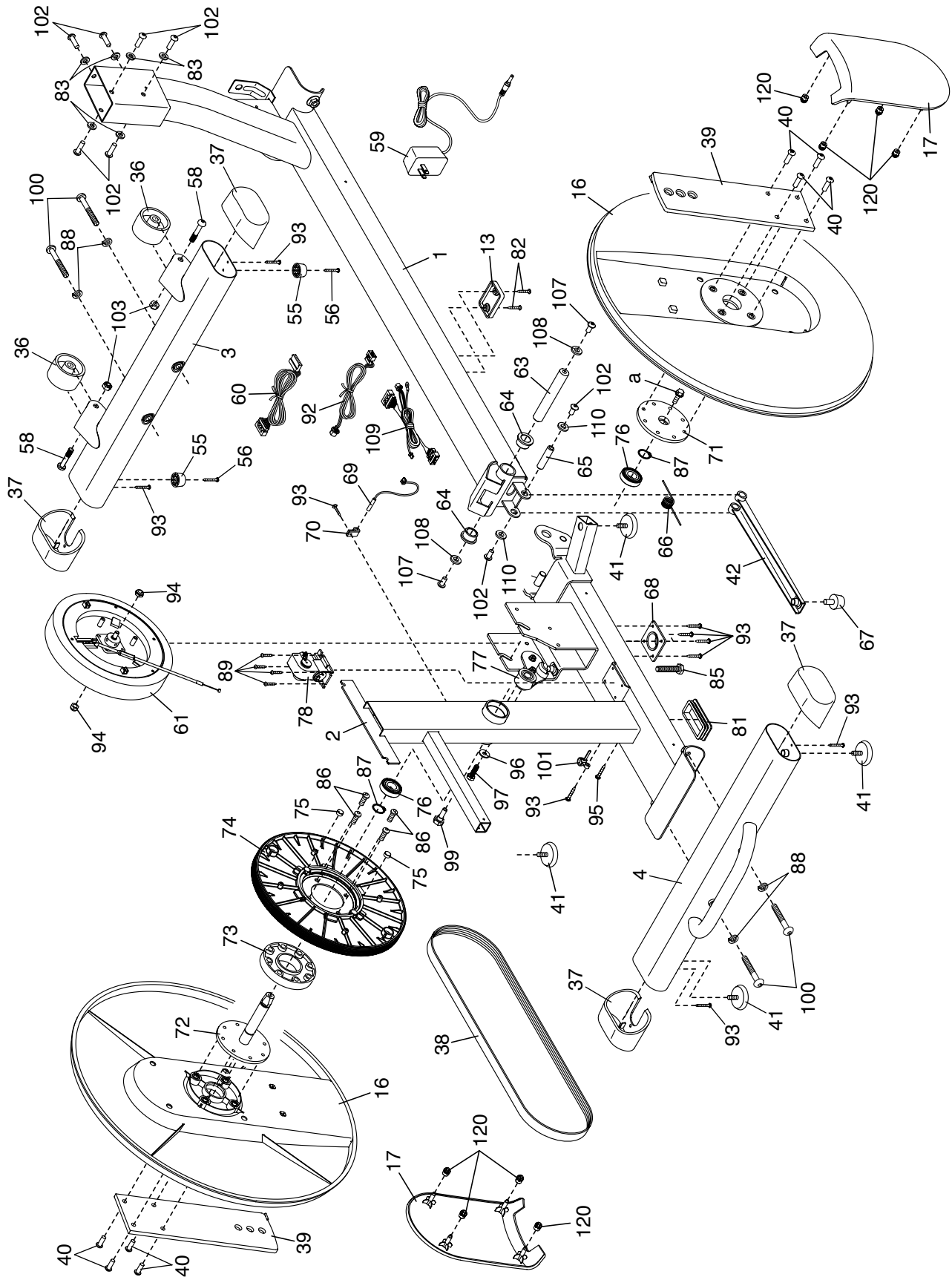

EXPLODED DRAWING C

Model No. PFEL55911.6 R0113A

