

EXPLODED DRAWING A

Model No. PFEL55911.8 R0514A

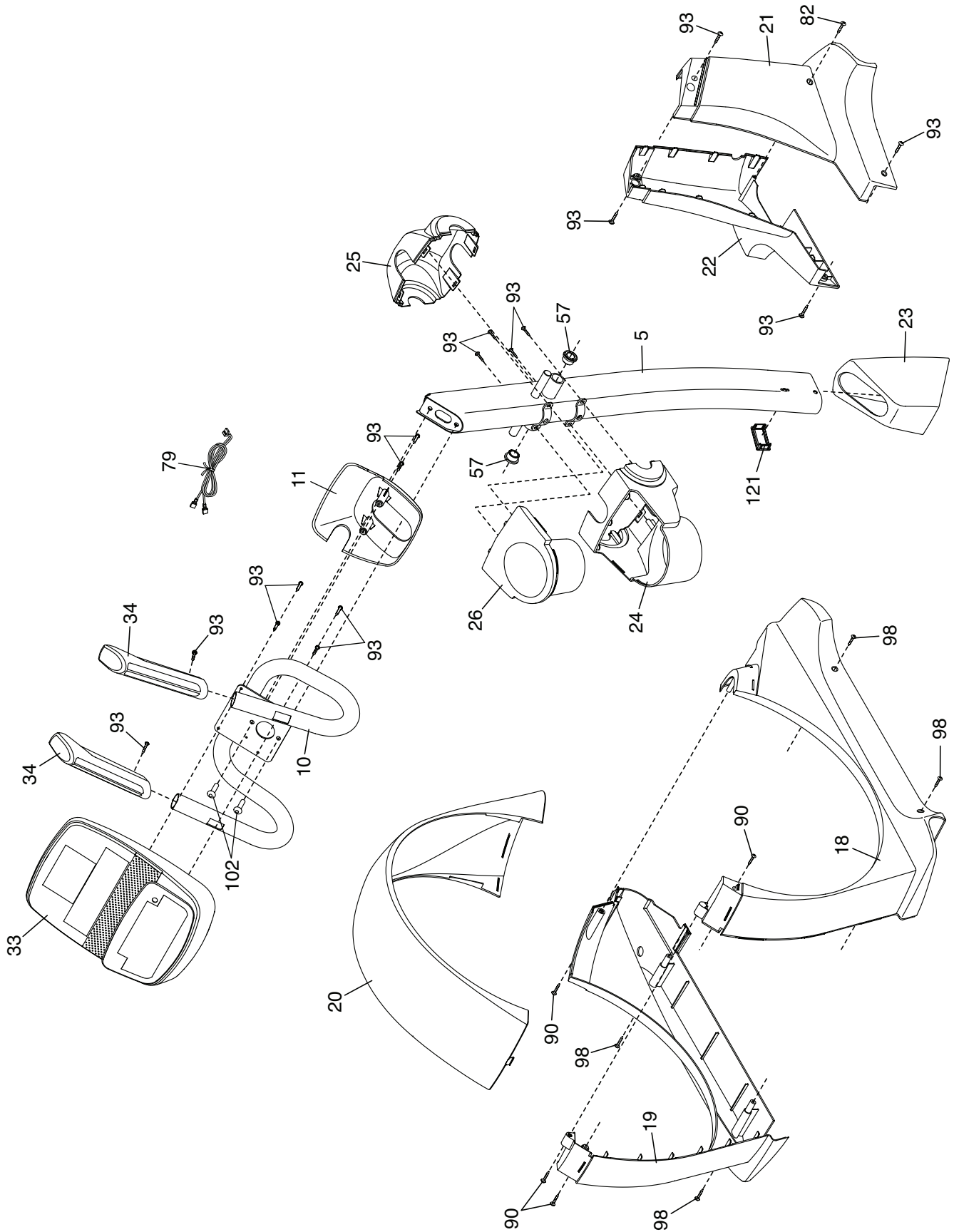

EXPLODED DRAWING B

Model No. PFEL55911.8 R0514A

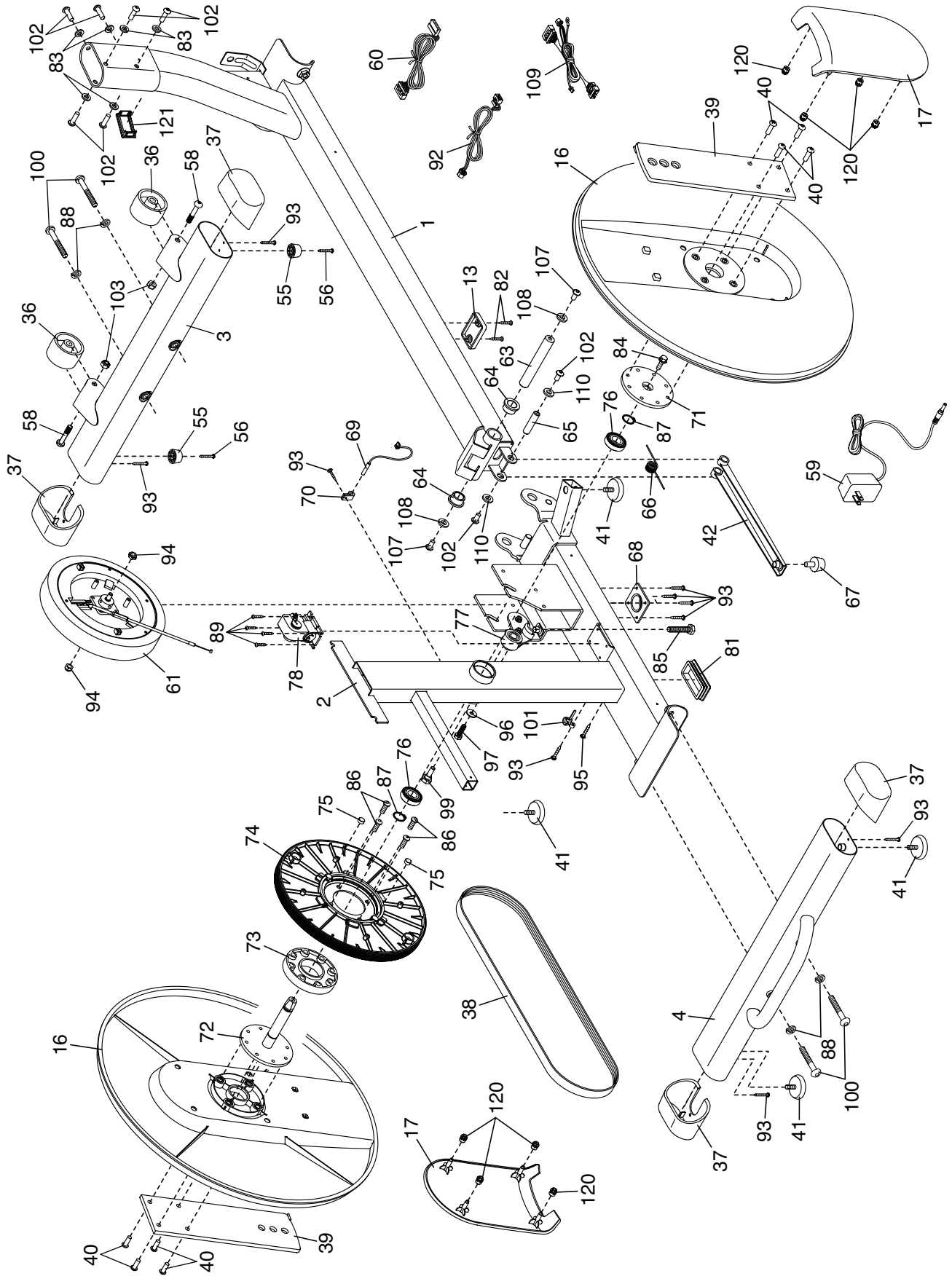

EXPLODED DRAWING C

Model No. PFEL55911.8 R0514A

