

EXPLODED DRAWING A

Model No. PFEL55921.1 R0821A

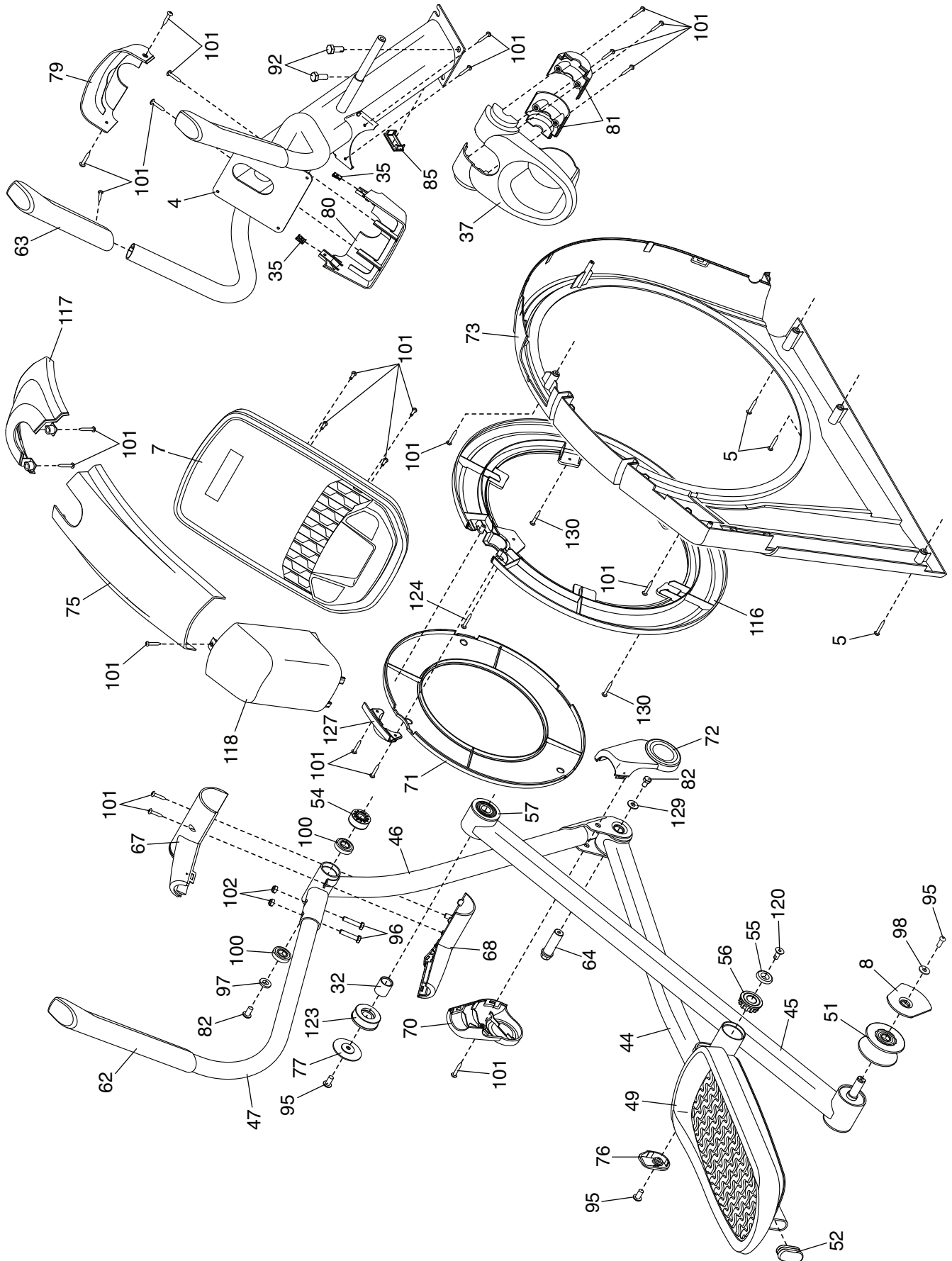

EXPLODED DRAWING B

Model No. PFEL55921.1 R0821A

