

# EXPLODED DRAWING A—Model No. PFEL57907.0

R1107A

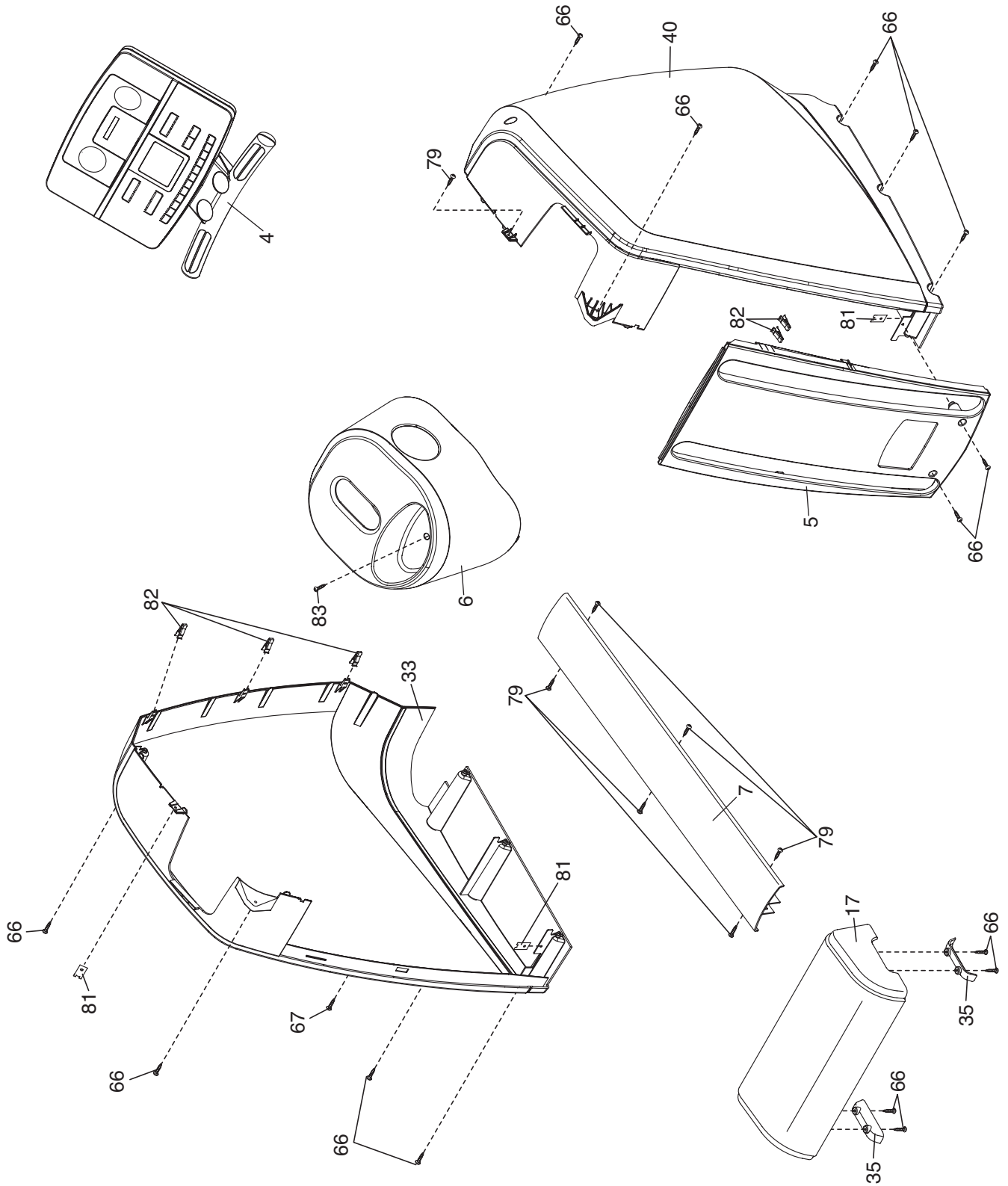

# EXPLODED DRAWING B – Model No. PFEL57907.0

R1107A

